

Milí priatelia,

produkty značky NEDES sú na trhu už viac ako 10 rokov a tešia sa čoraz väčšej obľube na domácom aj zahraničnom trhu. Veľmi nás teší, že si naše výrobky nachádza stále viac klientov, ale samozrejme aj stabilná vzájomná spolupráca s dlhodobými zákazníkmi.

Je nám ct'ou predstaviť Vám nový katalóg s rozmanitou kolekciov novínok, ktoré veríme, že potešia všetkých svojou kvalitou a funkčnosťou. Každý výrobok bol starostlivo navrhnutý a vyrobený s dôrazom na spoľahlivosť, efektivitu, a teda stále vyššiu úsporu elektrickej energie k pomeru s výkonom. Nájdete tu nové produkty so SMART technológiou, solárnym nabitím, ale aj mnoho dizajnových produktov a výrobkov so špeciálnymi funkciami.

Naším cieľom je aj naďalej vyvíjať nové výrobky s najvyššou kvalitou a prinášať ich na Európsky trh.

V mene celého tímu NEDES srdečne ďakujeme všetkým našim zákazníkom za prejavenu dôveru a budeme sústreďovať všetku energiu na to, aby sme Vás nesklamali.

S pozdravom

Dear friends,

NEDES brand products have been on the market for over 10 years and are increasingly popular both domestically and internationally. We are delighted that our products are finding more clients, fostering stable partnerships with long-term customers.

It is a honor to present to You our new catalog featuring a diverse collection of innovations. We believe these products will please everyone with their quality and functionality. Each item has been carefully designed and manufactured with an emphasis on reliability, efficiency, and a constant focus on energy savings in relation to performance. You will find new products with SMART technology, solar charging, as well as many design-oriented items and products with special features.

Our goal is to continue developing new products of the highest quality and bring them to the European market.

On behalf of the entire NEDES team, we sincerely thank all our customers for their trust and will concentrate all our efforts to ensure we do not disappoint You.

Best regards



Ing. Erik KOTLAN, PhD.
konateľ spoločnosti / CEO

6 - 17
SMART LIGHTS



18 - 23
LED STREET LIGHTS



24 - 31
LED Highbay Lights



32 - 37
LED EMERGENCY LIGHTS



38 - 49
LED CEILING LIGHTS



50 - 53
VENTS WITH LED LIGHTS





54 - 57
LED SURFACE LIGHTS



58 - 63
LED DOWNLIGHTS



64 - 75
LED LINEAR LIGHTS



76 - 79
LIGHT FIXTURES



80 - 89
**LED DESK LAMPS
& LED FLOOR LAMPS**

90 - 101
LED FLASH LIGHTS



102 - 117
LED PANELS



118 - 124
**LED GROUND LIGHTS
& LED GARDEN LIGHTS**



125
CONNECTORS



126 - 127
SOLAR LED LIGHTS



128 - 143
LED FLOOD LIGHTS





144 - 165
LED FILAMENTS



166 - 181
LED BULBS



182 - 184
LED TUBES



185
LAMP HOLDERS



186 - 191
CABLE TIES



192 - 195
INSULATION TAPES

40W



F

art.nr.:
LNL134W



1/25



SMART LED	4300lm (360°)	3000K ~ 6500K	CRI ≥ 80	Pnet ≥ 0.5W
IP40	IK08	AC 180-265V	50Hz	-25°C ~ +65°C
	0% 100%	30.000h	20.000	120°
UV free	Hg free	<1.0sec		

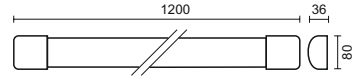

40W



E

art.nr.:
LNL334/3W



1/25



SMART LED	5200lm (360°)	3000K ~ 6500K	CRI ≥ 80	Pnet ≥ 0.5W
IP65	IK08	AC 180-265V	50Hz	-25°C ~ +65°C
	0% 100%	30.000h	20.000	120°
UV free	Hg free	<1.0sec		

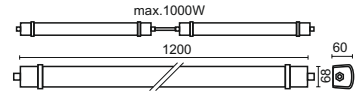

30W



F

art.nr.:
LF6033W



1/20



SMART LED	2800lm (120°)	2800lm (φuse)	3000lm (TOTAL)	3000K ~ 6500K
IP65	IK08	AC 180-265V	50Hz	CRI ≥ 80
	0% 100%	30.000h	25.000	-25°C ~ +45°C
110°	UV free	Hg free	<1.0sec	0.5m

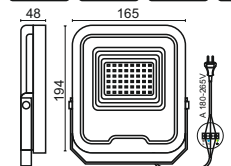

SMART LED	520Lm (120°)	520Lm (Φuse)	620Lm (TOTAL)	3000K ~ 6500K
IP44	AC 220-240V	50Hz	CRI ≥ 80	Pnet ≥ 0.5W
0% 100%	30.000h	20.000	-15°C ~ +55°C	
	UV free	Hg free		
120°			0.5m	0.2m
<1.0sec				

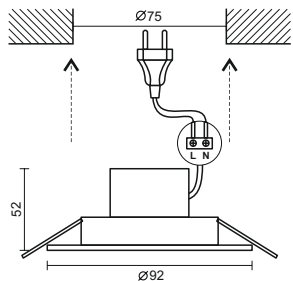

Google Home amazon alexa



1 / 100



tuya



F art.nr.: LDL163W

Google Home amazon alexa



1 / 100



tuya



F art.nr.: LDL163/SW

SMART LED	730Lm (120°)	730Lm (Φuse)	870Lm (TOTAL)	3000K ~ 6500K
IP44	AC 220-240V	50Hz	CRI ≥ 80	Pnet ≥ 0.5W
0% 100%	30.000h	20.000	-15°C ~ +55°C	
	UV free	Hg free		
120°			0.5m	0.2m
<1.0sec				

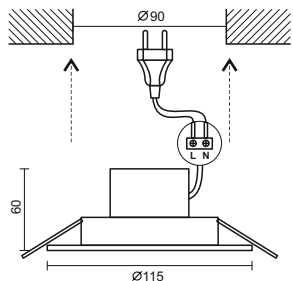

Google Home amazon alexa



1 / 50



tuya



F art.nr.: LDL164W

Google Home amazon alexa



1 / 50



tuya



F art.nr.: LDL164/SW

6W

amazon alexa Google Home



Bluetooth
Wi-Fi

F

art.nr.: LPL131W

Smart Life

tuya



1/40

6W

amazon alexa Google Home



Bluetooth
Wi-Fi

F

art.nr.: LPL231W

Smart Life

tuya



1/40

SMART LED	590Lm (360°)	3000K ~ 6500K	CRI ≥ 80	Pnet ≥ 0.5W
IP20	AC 180-265V	50/60 Hz	-5°C ~ +40°C	120°
	0% 100%	30.000h	30.000	<1.0sec
UV free	Hg free	0.5m	0.2m	Wi-Fi
Bluetooth				

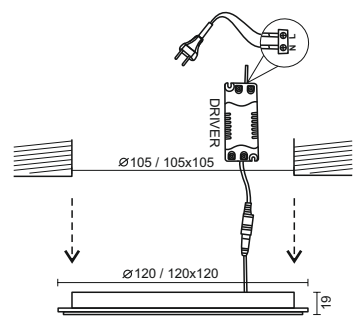

12W

amazon alexa Google Home



Bluetooth
Wi-Fi

F

art.nr.: LPL133W

Smart Life

tuya



1/40

12W

amazon alexa Google Home



Bluetooth
Wi-Fi

F

art.nr.: LPL233W

Smart Life

tuya



1/40

SMART LED	1200Lm (360°)	3000K ~ 6500K	CRI ≥ 80	Pnet ≥ 0.5W
IP20	AC 180-265V	50/60 Hz	-5°C ~ +40°C	120°
	0% 100%	30.000h	30.000	<1.0sec
UV free	Hg free	0.5m	0.2m	Wi-Fi
Bluetooth				

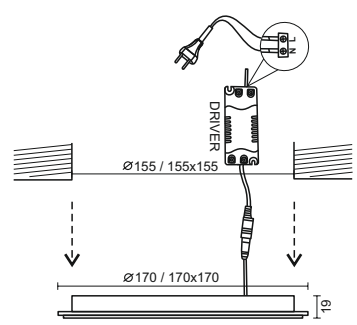

24W

SMART LED	2800lm (360°)	1700lm (TOTAL)	2700K ~ 6500K	0% 100%
IP20	AC 220-240V	50/60 Hz	CRI ≥ 80	120°
	0.5m	30.000h	25.000	-5°C ~ +40°C
UV free	Hg free	<1.0sec	Pnet 0.31W	Psb 0.31W

9 EXCLUSIVE series

amazon alexa

Google Home

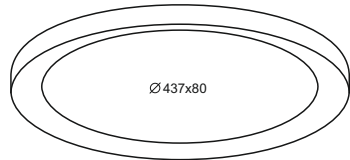

Ø 437x80



Bluetooth



1 / 5



tuya



art.nr.:
LC951U

48W

SMART LED	5600lm (360°)	3400lm (TOTAL)	2700K ~ 6500K	0% 100%
IP20	AC 220-240V	50/60 Hz	CRI ≥ 80	120°
	0.5m	30.000h	25.000	-5°C ~ +40°C
UV free	Hg free	<1.0sec	Pnet 0.31W	Psb 0.31W

9 EXCLUSIVE series

amazon alexa

Google Home

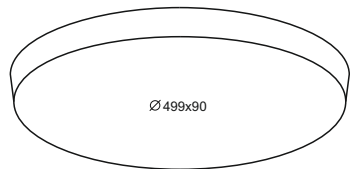

Ø 499x90



Bluetooth



1 / 1



tuya



art.nr.:
LC942W

48W

Google Home amazon alexa

9 EXCLUSIVE series

SMART LED	5600.Lm (360°)	3400.Lm (TOTAL)	2700K ~ 6500K	0% 100%
IP20	AC 220-240V	50/60 Hz	CRI ≥ 80	120°
	0.5m	30.000h	25.000	-5°C ~ +40°C
UV free	Hg free	<1.0sec	Pnet 0.31W	Psb 0.31W

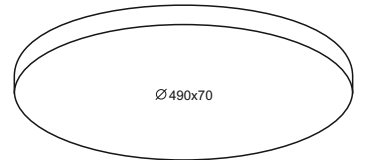

art.nr.: LC912T



1/1



48W

Google Home amazon alexa

9 EXCLUSIVE series

SMART LED	5600.Lm (360°)	3400.Lm (TOTAL)	2700K ~ 6500K	0% 100%
IP20	AC 220-240V	50/60 Hz	CRI ≥ 80	120°
	0.5m	30.000h	25.000	-5°C ~ +40°C
UV free	Hg free	<1.0sec	Pnet 0.31W	Psb 0.31W

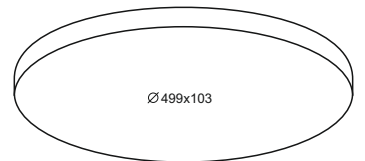

art.nr.: LC902C



1/1



48W

SMART LED	5600.Lm (360°)	3400.Lm (TOTAL)	2700K ~ 6500K	0% 100%
IP20	AC 220-240V	50/60 Hz	CRI ≥ 80	120°
UV free	Hg free	<1.0sec	Pnet 0.31W	Psb 0.31W
Bluetooth	WiFi			

9 EXCLUSIVE series

amazon alexa

Google Home



Bluetooth

WiFi

1/1



tuya

Smart Life

art.nr.: LC902AS/SI

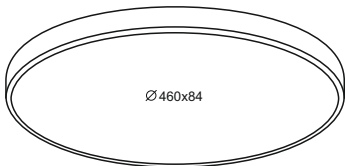

Ø 460x84

48W

SMART LED	5600.Lm (360°)	3400.Lm (TOTAL)	2700K ~ 6500K	0% 100%
IP20	AC 220-240V	50/60 Hz	CRI ≥ 80	120°
UV free	Hg free	<1.0sec	Pnet 0.31W	Psb 0.31W
Bluetooth	WiFi			

9 EXCLUSIVE series

amazon alexa

Google Home



Bluetooth

WiFi

1/1



tuya

Smart Life

art.nr.: LC902AS/WH

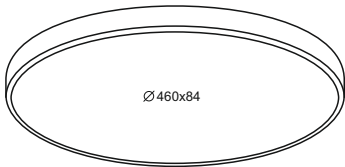

Ø 460x84

48W

Google Home amazon alexa

9 EXCLUSIVE series

SMART LED	5600.Lm (360°)	3400.Lm (TOTAL)	2700K ~ 6500K	0% 100%
IP20	AC 220-240V	50/60 Hz	CRI ≥ 80	120°
	0.5m	30.000h	25.000	-5°C ~ +40°C
UV free	Hg free	<1.0sec	Pnet 0.31W	Psb 0.31W



Bluetooth Wi-Fi

art.nr.: LC902AS/GD

Smart Life tuya

8 585040 907097

1/1

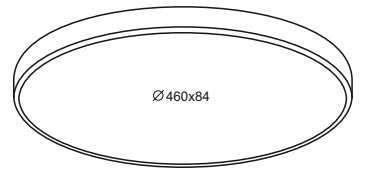

48W

Google Home amazon alexa

9 EXCLUSIVE series

SMART LED	5600.Lm (360°)	3400.Lm (TOTAL)	2700K ~ 6500K	0% 100%
IP20	AC 220-240V	50/60 Hz	CRI ≥ 80	120°
	0.5m	30.000h	25.000	-5°C ~ +40°C
UV free	Hg free	<1.0sec	Pnet 0.31W	Psb 0.31W



Bluetooth Wi-Fi

art.nr.: LC902AS/BK

Smart Life tuya

8 585040 907103

1/1

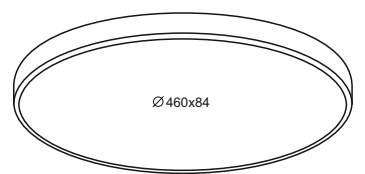

48W

SMART LED	5600.lm (360°)	3400.lm (TOTAL)	2700K ~ 6500K	0% 100%
IP20	AC 220-240V	50/60 Hz	CRI ≥ 80	120°
	0.5m	30.000h	25.000	-5°C ~ +40°C
UV free	Hg free	<1.0sec	Pnet 0.31W	Psb 0.31W

9 EXCLUSIVE series



1/1



art.nr.: LC9021

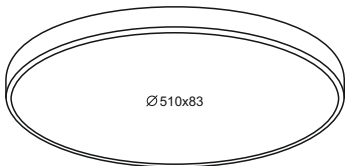

Ø510x83

48W

SMART LED	5600.lm (360°)	3400.lm (TOTAL)	2700K ~ 6500K	0% 100%
IP20	AC 220-240V	50/60 Hz	CRI ≥ 80	120°
	0.5m	30.000h	25.000	-5°C ~ +40°C
UV free	Hg free	<1.0sec	Pnet 0.31W	Psb 0.31W

9 EXCLUSIVE series



1/1



art.nr.: LC9021B

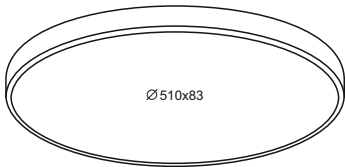

Ø510x83

48W

Google Home amazon alexa

9 EXCLUSIVE series

SMART LED	5600.Lm (360°)	3400.Lm (TOTAL)	2700K ~ 6500K	0% 100%
IP20	AC 220-240V	50/60 Hz	CRI ≥ 80	120°
	0.5m	30.000h	25.000	-5°C ~ +40°C
UV free	Hg free	<1.0sec	Pnet 0.31W	Psb 0.31W



Bluetooth
Wi-Fi

art.nr.: LC902Y

Smart Life tuya 8 585040 906977

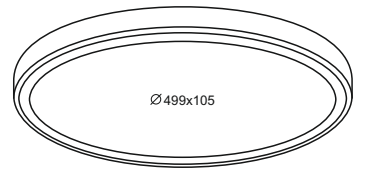

48W

Google Home amazon alexa

9 EXCLUSIVE series

SMART LED	5600.Lm (360°)	3400.Lm (TOTAL)	2700K ~ 6500K	0% 100%
IP20	AC 220-240V	50/60 Hz	CRI ≥ 80	120°
	0.5m	30.000h	25.000	-5°C ~ +40°C
UV free	Hg free	<1.0sec	Pnet 0.31W	Psb 0.31W



Bluetooth
Wi-Fi

art.nr.: LC902YB

Smart Life tuya 8 585040 907066

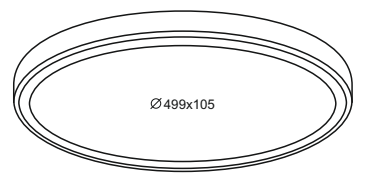

48W

SMART LED	5600 _{lm} (360°)	3400 _{lm} (TOTAL)	2700K ~ 6500K	0% 100%
IP20	AC 220-240V	50/60 Hz	CRI ≥ 80	120°
UV free	Hg free	30.000h	25.000	-5°C ~ +40°C
Bluetooth	WiFi	UV free <1.0sec	Pnet 0.31W	Psb 0.31W

9 EXCLUSIVE series



1/1



art.nr.: LC902MB

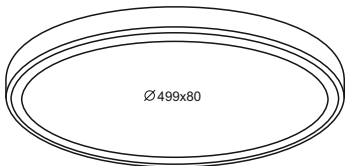

SMART LED	5600 _{lm} (360°)	3400 _{lm} (TOTAL)	2700K ~ 6500K	0% 100%
IP20	AC 220-240V	50/60 Hz	CRI ≥ 80	120°
UV free	Hg free	30.000h	25.000	-5°C ~ +40°C
Bluetooth	WiFi	UV free <1.0sec	Pnet 0.31W	Psb 0.31W

9 EXCLUSIVE series



1/1



art.nr.: LC902MB/S

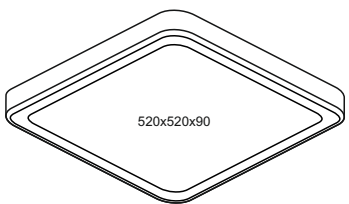

48W



9 EXCLUSIVE series

SMART LED	5600.lm (360°)	3400.lm (TOTAL)	2700K ~ 6500K	0% 100%
IP20	AC 220-240V	50/60 Hz	CRI ≥ 80	120°
	0.5m	30.000h	25.000	-5°C ~ +40°C
UV free	Hg free	<1.0sec	Pnet 0.31W	Psb 0.31W



art.nr.: LC902BB

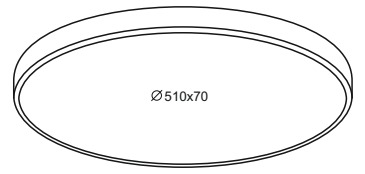

48W



9 EXCLUSIVE series

SMART LED	5600.lm (360°)	3400.lm (TOTAL)	2700K ~ 6500K	0% 100%
IP20	AC 220-240V	50/60 Hz	CRI ≥ 80	120°
	0.5m	30.000h	25.000	-5°C ~ +40°C
UV free	Hg free	<1.0sec	Pnet 0.31W	Psb 0.31W

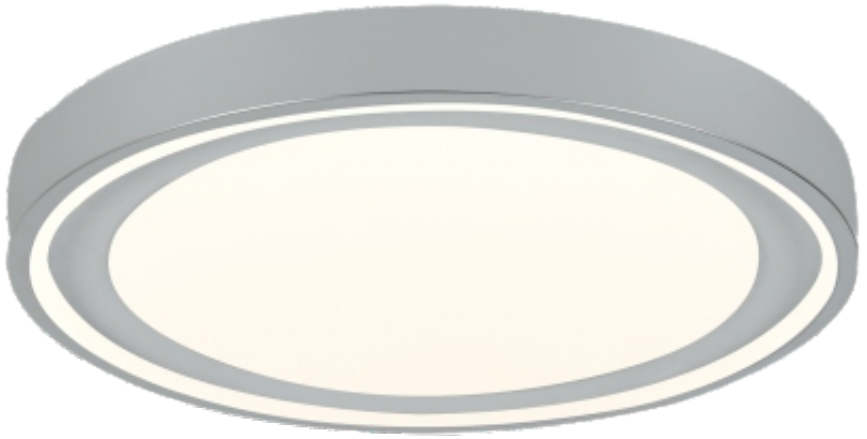

art.nr.: LC902SS

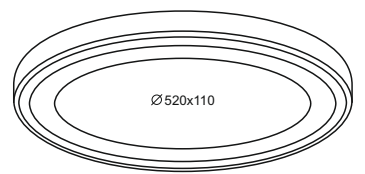

48W

SMART LED	5600.lm (360°)	3400.lm (TOTAL)	2700K ~ 6500K	0% 100%
IP20	AC 220-240V	50/60 Hz	CRI>=80	120°
UV free	Hg free	30.000h	25.000	-5°C ~ +40°C
Bluetooth	WiFi	<1.0sec	Pnet 0.31W	Psb 0.31W

9 EXCLUSIVE series



1/1



art.nr:
LC912R

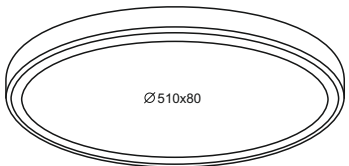

SMART LED	5600.lm (360°)	3400.lm (TOTAL)	2700K ~ 6500K	0% 100%
IP20	AC 220-240V	50/60 Hz	CRI>=80	120°
UV free	Hg free	30.000h	25.000	-5°C ~ +40°C
Bluetooth	WiFi	<1.0sec	Pnet 0.31W	Psb 0.31W

9 EXCLUSIVE series



1/1



art.nr:
LC902JB

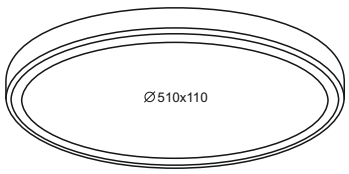

500W



art.n.:
LSL322



5000 Lm	4000K	AC 170-400V	50/60 Hz	Pf ≥ 0.9
IP67	IK07	0% 100%	60x 140°	-20°C +50°C
	UV free	Hg free	35.000h	
	<1.0sec			

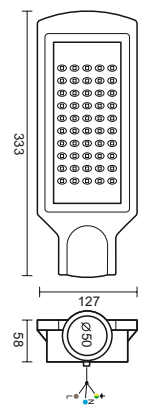

HOLDER

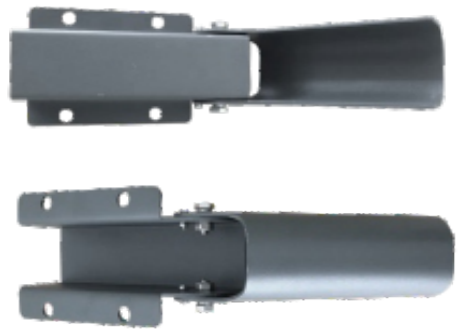

art.n.:
AAS11

USED FOR:
LSL322



50W

5000 Lm	4000K	AC 170-400V	50/60 Hz	Pf≥0.9
IP67	IK07	0% 100%	60x 140°	-20°C +50°C
UV free	Hg free	35.000h	20.000	
<1.0sec				

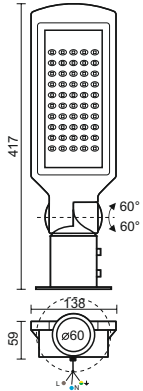

1 / 12



art.nr.:
LSL322H

5000 Lm	4000K	AC 170-400V	50/60 Hz	Pf≥0.9
IP67	IK07	0% 100%	60x 140°	-20°C +50°C
UV free	Hg free	35.000h	20.000	
<1.0sec	<10LUX			

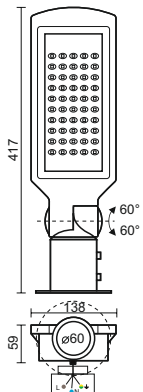

SENSOR
<10LUX



1 / 10



art.nr.:
LSL322HS

30W



art.nr.:
LSL321N



1/12

3800Lm (90°)	3800Lm (Φuse)	4000K
IP65	IK07	0% 100%
AC	50/60 Hz	170-400V
60x 140°	-20°C +50°C	35.000h
<1.0sec	Pf≥0.9	UV free
		Hg free

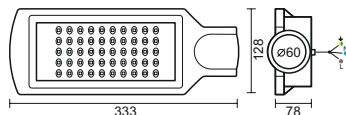

50W



art.nr.:
LSL322N



1/12

6100Lm (90°)	6100Lm (Φuse)	4000K
IP65	IK07	0% 100%
AC	50/60 Hz	170-400V
60x 140°	-20°C +50°C	35.000h
<1.0sec	Pf≥0.9	UV free
		Hg free

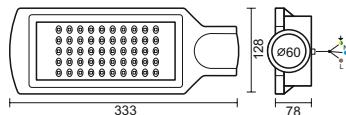

100W



art.nr.:
LSL323N



1/10

12000Lm (90°)	12000Lm (Φuse)	4000K
IP65	IK07	0% 100%
AC	50/60 Hz	170-400V
60x 140°	-20°C +50°C	35.000h
<1.0sec	Pf≥0.9	UV free
		Hg free

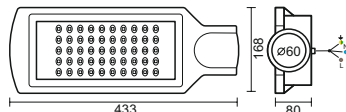

5000Lm (120°) (Φuse)	5800Lm (↑ TOTAL)	5000K
IP65	IK08	AC 100-277V
0% 100%	50Hz	
70x 140°	-25°C +50°C	50.000h
<1.0sec	CRI≥80	Pf≥0.95
UV free	Hg free	

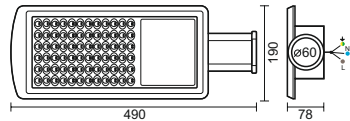

art.nr.:
LSL521

7300Lm (120°) (Φuse)	8700Lm (↑ TOTAL)	5000K
IP65	IK08	AC 100-277V
0% 100%	50Hz	
70x 140°	-25°C +50°C	50.000h
<1.0sec	CRI≥80	Pf≥0.95
UV free	Hg free	

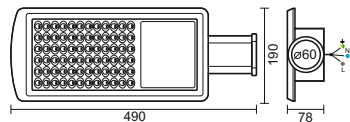

60W



art.nr.:
LSL522



60W



art.nr.:
LSL512

11600Lm (360°)	AC 100-277V	50Hz	-25°C +50°C
IP65	IK08	0% 100%	70x 140°
UV free	Pf=0.95	CRI=80	<1.0sec
Hg free	50.000h	30.000	

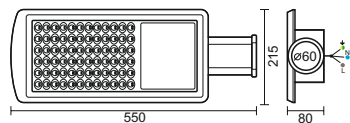

80W



art.nr.:
LSL523



80W



art.nr.:
LSL513

30W



2700K

30W



5000K



art.nr.:
LSL721



1 / 10



art.nr.:
LSL721



1 / 10

4500Lm (360°)	4500Lm (fuse)	50Hz
IP65	IK08	0% 100%
AC 100-277V	AC	<1.0sec
70x 140°	-25°C +50°C	50.000h
Pf≥0.95	CRI≥80	UV free
		Hg free

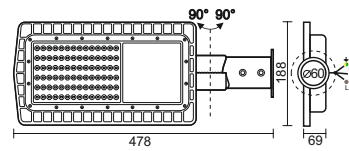

60W

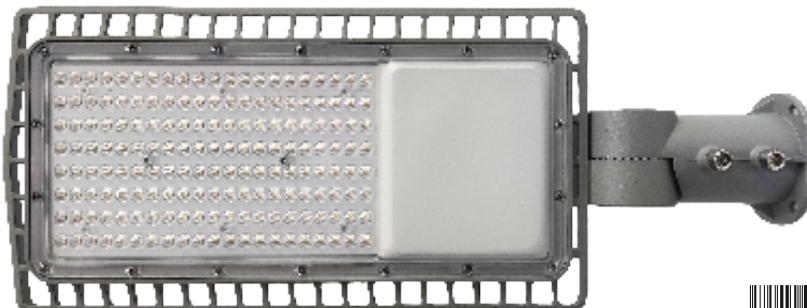

art.nr.:
LSL722



1 / 10

9000Lm (360°)	9000Lm (fuse)	5000K
IP65	IK08	0% 100%
AC 100-277V	AC	50Hz
70x 140°	-25°C +50°C	50.000h
Pf≥0.95	CRI≥80	UV free
		Hg free

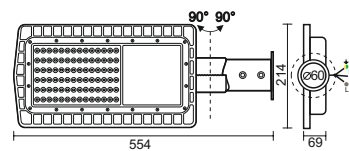

100W



art.nr.:
LSL723



1 / 10

15000Lm (360°)	15000Lm (fuse)	5000K
IP65	IK08	0% 100%
AC 100-277V	AC	50Hz
70x 140°	-25°C +50°C	50.000h
Pf≥0.95	CRI≥80	UV free
		Hg free

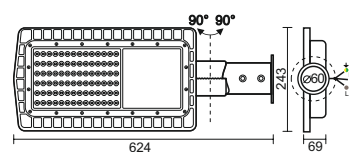

5800Lm (120°)	5800Lm (Φuse)	5000K
IP65	IK08	AC 100-277V
50/60 Hz	Pf≥0.95	
36x 106°	0% 100%	50.000h
<1.0sec	-25°C +50°C	30.000
	UV free	Hg free

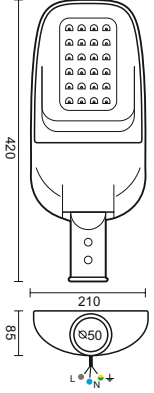

art.nr.:
LSL621/RP

ADAPTER



USED FOR:
LSL3.N
LSL5.



art.nr.:
AAS03

ADAPTER



USED FOR:
LSL322



art.nr.:
AAS02



USED FOR:
LSL322
LSL621/RP



ADAPTER

art.nr.:
AS02

100W



E

art.nr.:
LU421



1/8

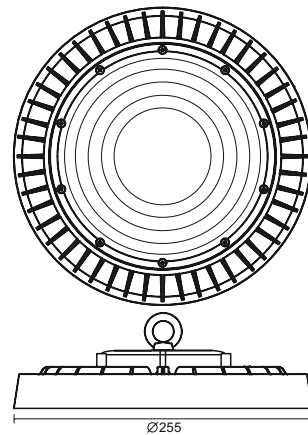

11000Lm (360°)	5000K	AC 220-240V	0% 100%
IP65	IK08	<1.0sec	50/60 Hz
UV free	Hg free	30.000h	25.000
0.5m	90°	Pf ≥ 96	

150W



PHILIPS
LED
SOSEN
DRIVER

D

art.nr.:
LU112/SR



1/4

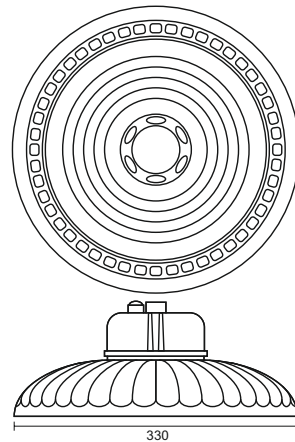

22500Lm (360°)	5000K	AC 90-305V	0% 100%
IP65	IK08	<1.0sec	50/60 Hz
UV free	Hg free	50.000h	30.000
0.5m	90°	SENSOR 5.8Ghz	Pf ≥ 96

BRACKET



art.nr.:
HU12



USED FOR:
LU112/SR

1/50

REMOTE



art.nr.:
RLU112



USED FOR:
LU112/SR

1/100

CR2025	3V
--------	----

100W

12000Lm (120°)	12000Lm (Φ use)	5000K
13000Lm (TOTAL Φ)	AC 180-265V	0% 100%
IP65	IK08	90°
	<1.0sec	50/60 Hz
	UV free	-30°C +55°C
	Hg free	30.000h
0.5m	Pf≥96	25.000

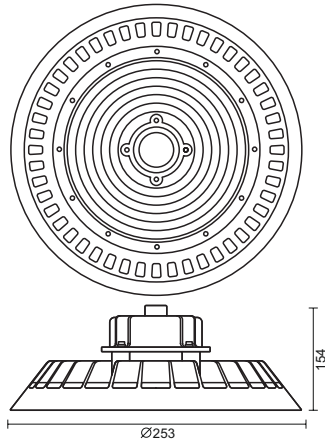

art.nr:
LU321

18000Lm (120°)	18000Lm (Φ use)	5000K
19500Lm (TOTAL Φ)	AC 180-265V	0% 100%
IP65	IK08	90°
	<1.0sec	50/60 Hz
	UV free	-30°C +55°C
	Hg free	30.000h
0.5m	Pf≥96	25.000

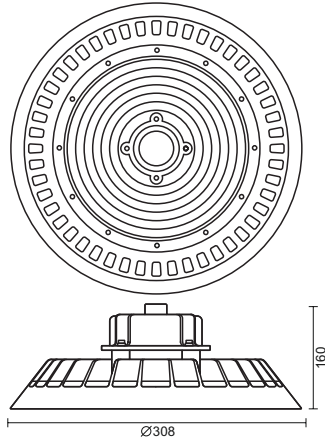

art.nr:
LU322

150W

24000Lm (120°)	24000Lm (Φ use)	5000K
26000Lm (TOTAL Φ)	AC 180-265V	0% 100%
IP65	IK08	90°
	<1.0sec	50/60 Hz
	UV free	-30°C +55°C
	Hg free	30.000h
0.5m	Pf≥96	25.000

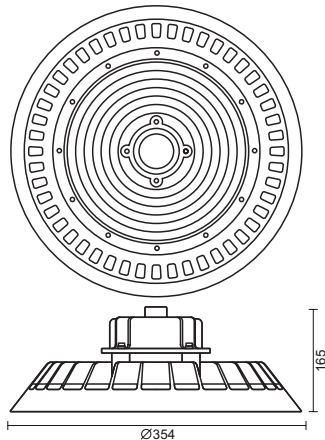

art.nr:
LU323

200W

100W



DIMMABLE
1-10V



15000Lm (360°)	5000K	AC 100-277V	0% 100%
IP65	IK08	<1.0sec	50/60 Hz
UV free	Hg free	50.000h	-30°C +55°C
0.5m	90°	CRI=80	Pf=96

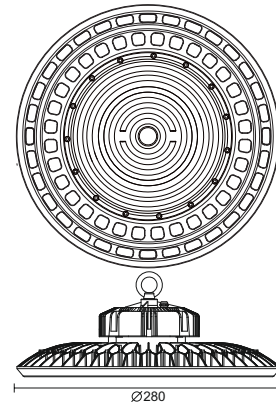

D

art.nr.:
LU221/1

1/4



150W



DIMMABLE
1-10V



22500Lm (360°)	5000K	AC 100-277V	0% 100%
IP65	IK08	<1.0sec	50/60 Hz
UV free	Hg free	50.000h	-30°C +55°C
0.5m	90°	CRI=80	Pf=96

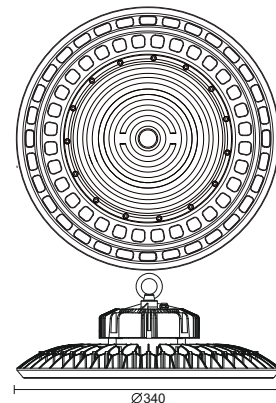

D

art.nr.:
LU222/1

1/4



150W

22500Lm (360°)	5000K	AC 100-277V	0% 100%
IP65	IK08	<1.0sec	50/60 Hz
UV free	Hg free	50.000h	-30°C ~ +55°C
0.5m	90°	CRI=80	Pf=96

DIMMABLE
DALI

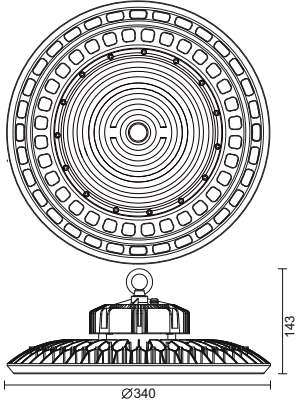

1/4



D

art.nr.:
LU222/DALI

200W

30000Lm (360°)	5000K	AC 100-277V	0% 100%
IP65	IK08	<1.0sec	50/60 Hz
UV free	Hg free	50.000h	-30°C ~ +55°C
0.5m	90°	CRI=80	Pf=96

DIMMABLE
1-10V

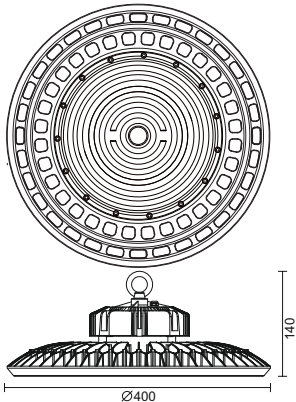

1/4



D

art.nr.:
LU223/1

COVER



BEAM
(60°)

USED FOR:
LU221

1 / 100

art.nr.:
CU21/60



COVER



BEAM
(60°)

USED FOR:
LU222

1 / 100

art.nr.:
CU22/60



COVER



BEAM
(60°)

USED FOR:
LU223

1 / 100

art.nr.:
CU23/60



COVER



BEAM
(120°)

USED FOR:
LU221

1 / 100

art.nr.:
CU21/120



COVER



BEAM
(120°)

USED FOR:
LU222

1 / 100

art.nr.:
CU22/120



COVER



BEAM
(120°)

USED FOR:
LU223

1 / 100

art.nr.:
CU23/120



BRACKET



USED FOR:
LU221

1 / 50

art.nr.:
HU21



BRACKET



USED FOR:
LU222

1 / 50

art.nr.:
HU22



BRACKET



USED FOR:
LU223

1 / 50

art.nr.:
HU23



100W

16000Lm (120°)	16000Lm (Φ use)	5000K
17000Lm (TOTAL Φ)	AC 120-305V	0% 100% 90°
IP65	IK08	50/60 Hz
	UV free	Hg free
0.5m	Pf ≥ 96	50.000h 30.000

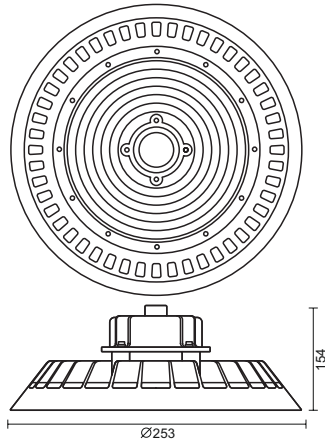

DIMMABLE
1-10V



1/4



art.nr.:
LU321/1

150W

23600Lm (120°)	23600Lm (Φ use)	5000K
25500Lm (TOTAL Φ)	AC 120-305V	0% 100% 90°
IP65	IK08	50/60 Hz
	UV free	Hg free
0.5m	Pf ≥ 96	50.000h 30.000

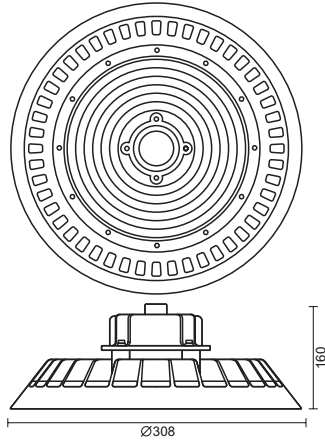

DIMMABLE
1-10V



1/4



art.nr.:
LU322/1

200W

31900Lm (120°)	31900Lm (Φ use)	5000K
34000Lm (TOTAL Φ)	AC 120-305V	0% 100% 90°
IP65	IK08	50/60 Hz
	UV free	Hg free
0.5m	Pf ≥ 96	50.000h 30.000

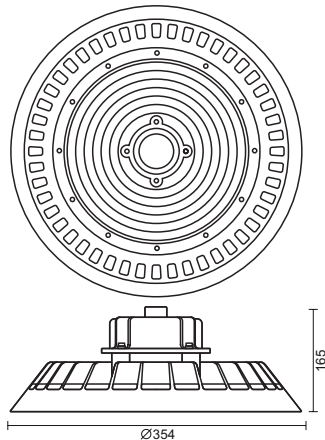

DIMMABLE
1-10V



1/4



art.nr.:
LU323/1

COVER



BEAM
(60°)

USED FOR:
LU321
LU321/1

1 / 100

art.nr.:
CU31/60



COVER



BEAM
(60°)

USED FOR:
LU322
LU322/1

1 / 10 / 100

art.nr.:
CU32/60



COVER



BEAM
(60°)

USED FOR:
LU323
LU323/1

1 / 100

art.nr.:
CU33/60



COVER



BEAM
(120°)

USED FOR:
LU321
LU321/1

1 / 100

art.nr.:
CU31/120



COVER



BEAM
(120°)

USED FOR:
LU322
LU322/1

1 / 10 / 100

art.nr.:
CU32/120



COVER



BEAM
(120°)

USED FOR:
LU323
LU323/1

1 / 100

art.nr.:
CU33/120



BRACKET



USED FOR:
LU321
LU321/1

1 / 50

art.nr.:
HU31



BRACKET



USED FOR:
LU322
LU322/1

1 / 50

art.nr.:
HU32



BRACKET



USED FOR:
LU323
LU323/1

1 / 50

art.nr.:
HU33



5W IP65 OUTDIM 0-10V IN DC 10-15V -20°C ~ +60°C

SENSOR 5.8Ghz

- L: (12V) --- (12V)
- N: (Dim-) --- (GND&Dim-)
- E: (Dim+) --- (Dim+)

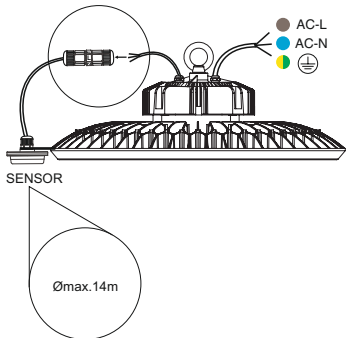

USED FOR:
LU221/1
LU222/1
LU223/1
LU321/1
LU322/1
LU323/1

1 / 10



art.nr:
SM2/1

2xAAA 1.5V

USED FOR:
SM2/1

1 / 100

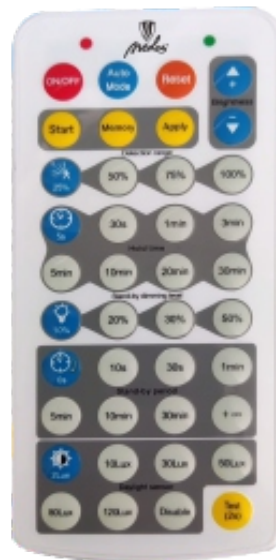

art.nr:
RLU2/1

3W



150 Lm	6000K	AC 100-240V	50/60 Hz	CRI ≥ 80
IP65	30 LED	120°	0% 100%	0°C ~ +40°C
	UV free	Hg free	50.000h	30.000
3h	80m²	0.5m	<1.0sec	

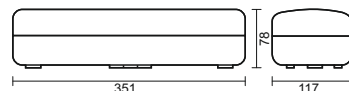

art.nr.: LEL101



1W



50Lm	6000K	AC 100-240V	50/60 Hz	CRI ≥ 80
IP20	8 LED	320°	0% 100%	0°C ~ +40°C
	UV free	Hg free	50.000h	30.000
3h	0.5m	<1.0sec		

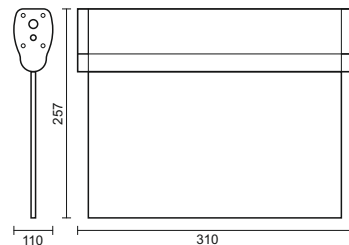

art.nr.: LEL201



30Lm	6000K	AC 100-240V	50/60 Hz	CRI≥80
IP20	7LED	320°	0% 100%	0°C ~ +40°C
	UV free	Hg free	50.000h	30.000
3h	0.5m	<1.0sec		

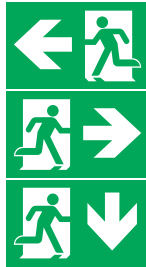

art.nr:
LEL202

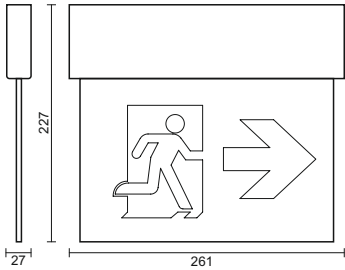

50Lm	6000K	AC 100-240V	50/60 Hz	CRI≥80
IP20	16LED	320°	0% 100%	0°C ~ +40°C
	UV free	Hg free	50.000h	30.000
3h	0.5m	<1.0sec		



art.nr:
LEL203

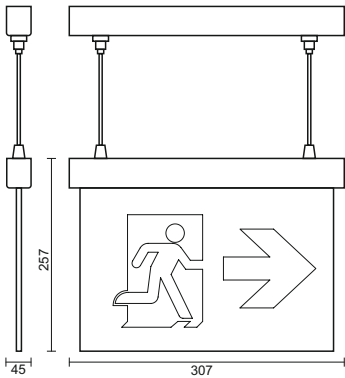



110 Lm	6000K	AC 100-240V	50/60 Hz	CRI ≥ 80
IP20	16 LED	140°	0% 100%	0°C ~ +40°C
	UV free	Hg free	50.000h	
3h	<1.0sec	0.5m		

art.nr.: LEL204

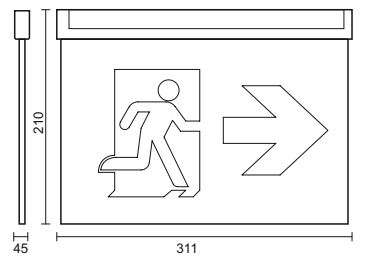

USED FOR: LEL204

1 / 50

art.nr.: HE01



USED FOR: LEL204

1 / 200

art.nr.: HE02



USED FOR: LEL204

1 / 100

art.nr.: HE03



100 Lm	6000K	AC 100-240V	50/60 Hz	CRI ≥ 80
IP20	18 LED	320°	0% 100%	0°C ~ +40°C
UV free	Hg free	50.000h	30.000	
3h	0.5m	<1.0sec		

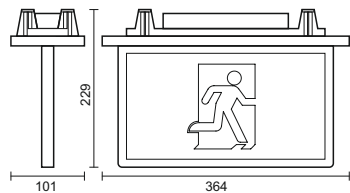

art.nr.:
LEL301

100 Lm	6000K	AC 100-240V	50/60 Hz	CRI ≥ 80
IP20	6 LED	120°	0% 100%	0°C ~ +40°C
UV free	Hg free	50.000h	30.000	
3h	0.5m	<1.0sec	80m²	



art.nr.:
LEL401

12W



1/20



art.n.:
LEL501

120Lm	160°	130Lm	93x 57°	6000K
IP20	AC 100-240V	50/60 Hz	0% 100%	0°C ~ +40°C
UV free	Hg free	50.000h	30.000	
3h	LED	CRI=80	<1.0sec	0.5m

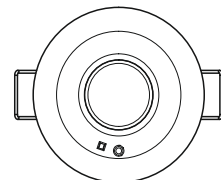

Ø49,8

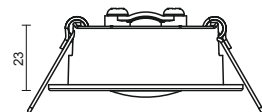

2W



1/20



art.n.:
LEL502

300Lm	160°	260Lm	93x 57°	6000K
IP20	AC 100-240V	50/60 Hz	0% 100%	0°C ~ +40°C
UV free	Hg free	50.000h	30.000	
3h	LED	CRI=80	<1.0sec	0.5m

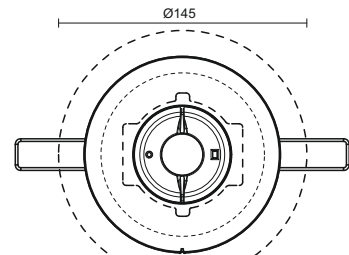

Ø145

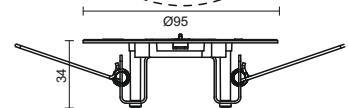

Ø95

34

330Lm 160°	280Lm 93x57°	6000K
IP65	AC 100-240V	50/60 Hz
UV free	Hg free	0% 100%
3h	LED	CRI=80
		<1.0sec
		0.5m

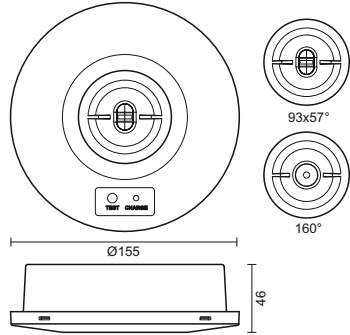

art.nr.:
LEL601

330Lm 160°	280Lm 93x57°	6000K
IP65	AC 100-240V	50/60 Hz
UV free	Hg free	0% 100%
3h	LED	CRI=80
		<1.0sec
		0.5m

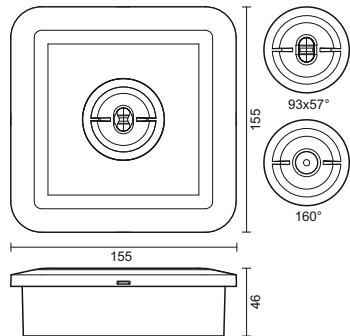

art.nr.:
LEL602

12W



art.nr.:
LCL421S

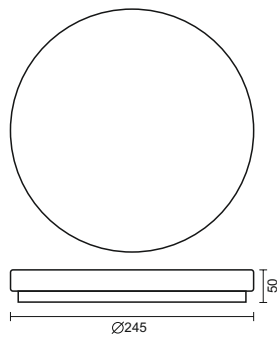

900 Lm	4000K	AC 180-260V	50/60 Hz	120°
IP20	0% 100%	CRI=80	0.5m	-15°C +45°C
	25.000h	20.000	UV free	Hg free
<1.0sec				

12W



art.nr.:
LCL421

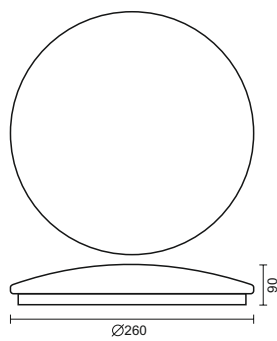

900 Lm	4000K	AC 180-260V	50/60 Hz	120°
IP20	0% 100%	CRI=80	0.5m	-15°C +45°C
	25.000h	20.000	UV free	Hg free
<1.0sec				

12W



art.nr.:
LCL421M

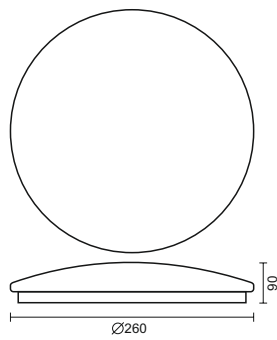

900 Lm	4000K	AC 180-260V	50/60 Hz	120°
IP20	0% 100%	CRI=80	0.5m	-15°C +45°C
	25.000h	20.000	UV free	Hg free
MICRO WAVE	SENSOR 2/4/6/8 m	SENSOR 0.6-1.5 m/s	SENSOR 5.8Ghz 50hz	<1.0sec
LUX 2/10/25/50/2000		SENSOR TIME 5s/30s/1min/3/5/10/20/30min		

12W

900 Lm	4000K	AC 180-260V	50/60 Hz	120°
IP44	0% 100%	CRI=80	0.5m	-15°C +45°C
25.000h	20.000	UV free	Hg free	
<1.0sec				

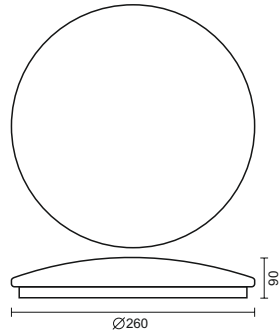

art.nr.:
LCL421/44

900 Lm	4000K	AC 180-260V	50/60 Hz	120°
IP44	0% 100%	CRI=80	0.5m	-15°C +45°C
25.000h	20.000	UV free	Hg free	
MICRO WAVE	SENSOR 2/4/6/8 m	SENSOR 0.6-1.5 m/s	SENSOR 5.86ghz 50hz	<1.0sec
LUX 2/10/25/50/2000	SENSOR TIME 5s/30s/1min/3/5/10/20/30min			

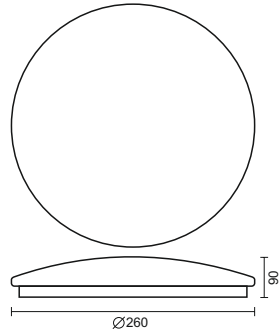

art.nr.:
LCL421M/44

900 Lm	4000K	AC 180-260V	50/60 Hz	120°
IP20	0% 100%	CRI=80	0.5m	-15°C +45°C
25.000h	20.000	UV free	Hg free	
PIR	SENSOR 4-10m	SENSOR 50hz	LUX 2-2000	<1.0sec
SENSOR TIME 3s-8min				

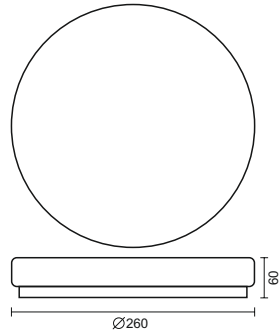

art.nr.:
LCL421P

12W

18W



art.nr.:
LCL422S

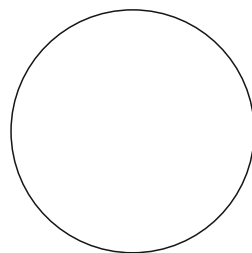

1300 Lm	4000K	AC 180-260V	50/60 Hz	120°
IP20	0% 100%	CRI=80	0.5m	-15°C +45°C
25.000h	20.000	UV free	Hg free	
<1.0sec				

18W



art.nr.:
LCL422S/44

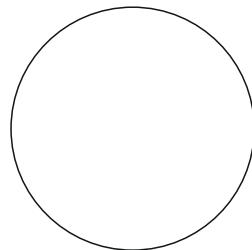

1300 Lm	4000K	AC 180-260V	50/60 Hz	120°
IP44	0% 100%	CRI=80	0.5m	-15°C +45°C
25.000h	20.000	UV free	Hg free	
<1.0sec				

18W



art.nr.:
LCL422M/44

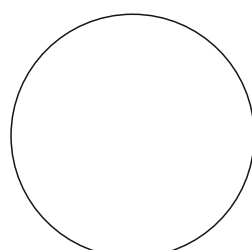

1300 Lm	4000K	AC 180-260V	50/60 Hz	120°
IP44	0% 100%	CRI=80	0.5m	-20°C +40°C
25.000h	20.000	UV free	Hg free	
MICRO WAVE	SENSOR 4/8 m	SENSOR 0.6-1.5 m/s	SENSOR 5.8Ghz 50hz	<1.0sec
LUX 25/2000	SENSOR TIME 5s/1min/3/10min			

24W

1800 Lm	4000K	AC 180-260V	50/60 Hz	120°
IP20	0% 100%	CRI=80	0.5m	-15°C ~ +45°C
	25.000h	20.000	UV free	Hg free
<1.0sec				

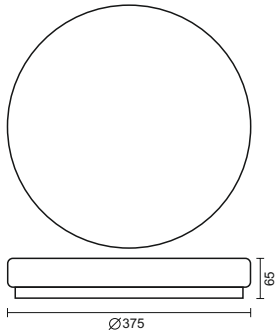

1 / 10

8 585040 908346



art.nr.
LCL423S

36W

2700 Lm	4000K	AC 180-260V	50/60 Hz	120°
IP20	0% 100%	CRI=80	0.5m	-15°C ~ +45°C
	25.000h	20.000	UV free	Hg free
<1.0sec				

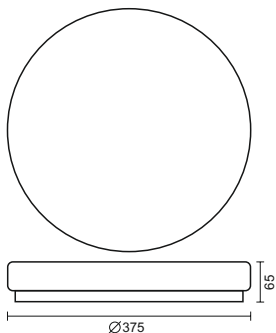

1 / 10

8 585040 908353



art.nr.
LCL424S

24W



art.nr.:
LCL533S



1 / 10

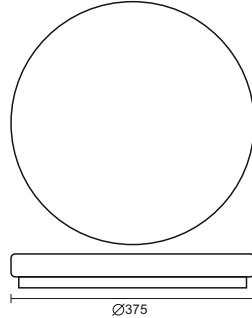

1800 Lm	3000K 6500K	AC 180-260V	50/60 Hz	120°
IP20	0% 100%	CRI=80	0.5m	-15°C +45°C
	25.000h	20.000	UV free	Hg free
	<1.0sec			

36W



art.nr.:
LCL534S



1 / 10

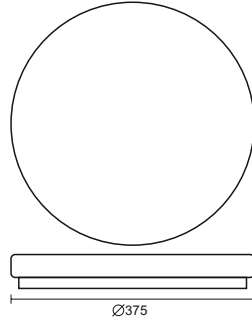

2700 Lm	3000K 6500K	AC 180-260V	50/60 Hz	120°
IP20	0% 100%	CRI=80	0.5m	-15°C +45°C
	25.000h	20.000	UV free	Hg free
	<1.0sec			

48W



art.nr.:
LCL535S



1 / 10

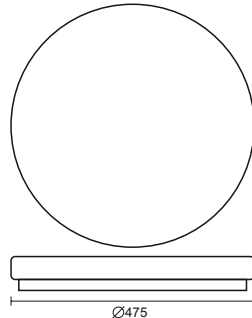

3600 Lm	3000K 6500K	AC 180-260V	50/60 Hz	120°
IP20	0% 100%	CRI=80	0.5m	-15°C +45°C
	25.000h	20.000	UV free	Hg free
	<1.0sec			

60W



art.nr.:
LCL536S



1 / 5

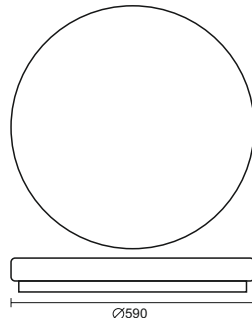

4500 Lm	3000K 6500K	AC 180-260V	50/60 Hz	120°
IP20	0% 100%	CRI=80	0.5m	-15°C +45°C
	25.000h	20.000	UV free	Hg free
	<1.0sec			

36W

2700 Lm	3000K ~ 6500K	AC 180-260V	50/60 Hz	120°
IP20	0% 100%	CRI=80	0.5m	-15°C ~ +45°C
	25.000h	20.000	UV free	Hg free
	<1.0sec			

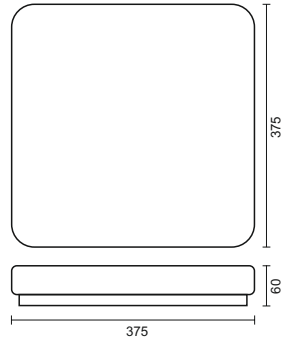

art.nr.:
LCL534S/S

48W

3600 Lm	3000K ~ 6500K	AC 180-260V	50/60 Hz	120°
IP20	0% 100%	CRI=80	0.5m	-15°C ~ +45°C
	25.000h	20.000	UV free	Hg free
	<1.0sec			

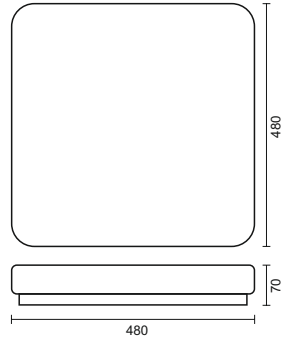

art.nr.:
LCL535S/S

60W

4500 Lm	3000K ~ 6500K	AC 180-260V	50/60 Hz	120°
IP20	0% 100%	CRI=80	0.5m	-15°C ~ +45°C
	25.000h	20.000	UV free	Hg free
	<1.0sec			

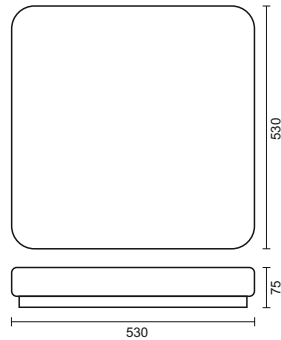

art.nr.:
LCL536S/S

36W



1/10

art.nr.:
LCL534AS

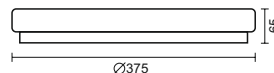
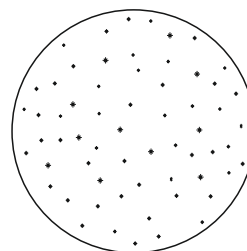

2700 Lm	3000K ~ 6500K	AC 180-260V	50/60 Hz	120°
IP20	0% 100%	CRI=80	0.5m	-15°C +45°C
	25.000h	20.000	UV free	Hg free
	<1.0sec			

48W



1/10

art.nr.:
LCL535AS

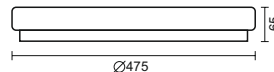
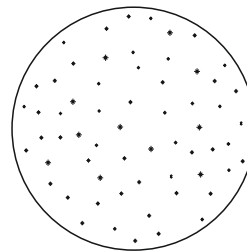

3600 Lm	3000K ~ 6500K	AC 180-260V	50/60 Hz	120°
IP20	0% 100%	CRI=80	0.5m	-15°C +45°C
	25.000h	20.000	UV free	Hg free
	<1.0sec			

60W



1/5

art.nr.:
LCL536AS

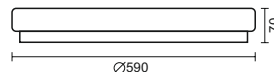
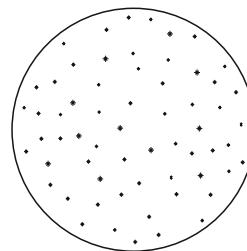

4500 Lm	3000K ~ 6500K	AC 180-260V	50/60 Hz	120°
IP20	0% 100%	CRI=80	0.5m	-15°C +45°C
	25.000h	20.000	UV free	Hg free
	<1.0sec			

36W

2700 Lm	3000K ~ 6500K	AC 180-260V	50/60 Hz	120°
IP20	0% 100%	CRI=80	0.5m	-15°C ~ +45°C
	25.000h	20.000	UV free	Hg free
<1.0sec				

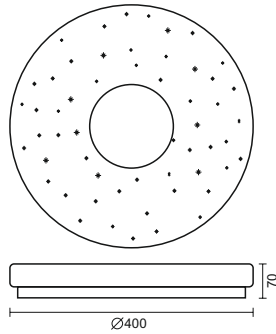

1 / 10



art.nr:
LCL534AU

3600 Lm	3000K ~ 6500K	AC 180-260V	50/60 Hz	120°
IP20	0% 100%	CRI=80	0.5m	-15°C ~ +45°C
	25.000h	20.000	UV free	Hg free
<1.0sec				

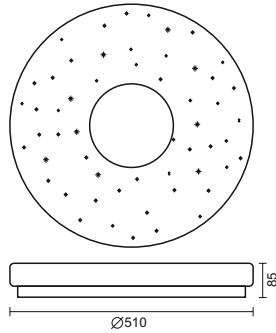

1 / 10



art.nr:
LCL535AU

48W

4500 Lm	3000K ~ 6500K	AC 180-260V	50/60 Hz	120°
IP20	0% 100%	CRI=80	0.5m	-15°C ~ +45°C
	25.000h	20.000	UV free	Hg free
<1.0sec				

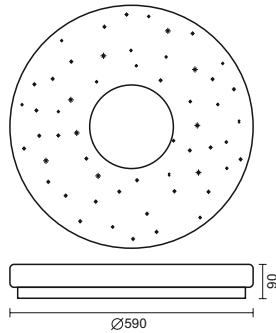

1 / 5



art.nr:
LCL536AU

60W

36W



1/10



art.nr.:
LCL534AD

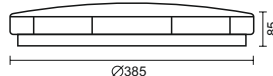
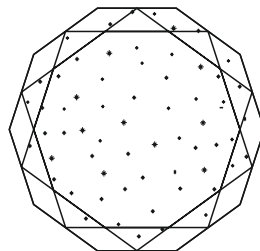

2700 Lm	3000K ~ 6500K	AC 180-260V	50/60 Hz	120°
IP20	0% 100%	CRI=80	0.5m	-15°C +45°C
	25.000h	20.000	UV free	Hg free
<1.0sec				

48W



1/10



art.nr.:
LCL535AD

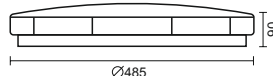
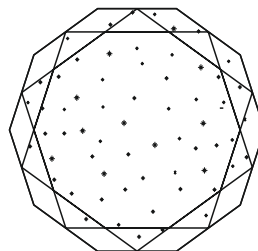

3600 Lm	3000K ~ 6500K	AC 180-260V	50/60 Hz	120°
IP20	0% 100%	CRI=80	0.5m	-15°C +45°C
	25.000h	20.000	UV free	Hg free
<1.0sec				

60W



1/5



art.nr.:
LCL536AD

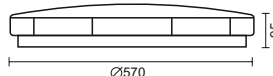
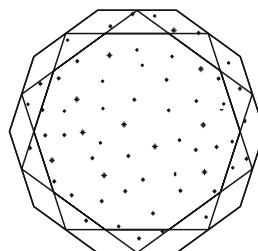

4500 Lm	3000K ~ 6500K	AC 180-260V	50/60 Hz	120°
IP20	0% 100%	CRI=80	0.5m	-15°C +45°C
	25.000h	20.000	UV free	Hg free
<1.0sec				

36W

2700 Lm	3000K ~ 6500K	AC 180-260V	50/60 Hz	120°
IP20	0% 100%	CRI=80	0.5m	-15°C ~ +45°C
	25.000h	20.000	UV free	Hg free
<math><1.0\text{sec}</math>				

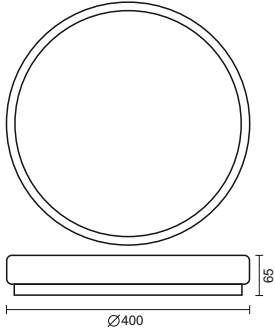

1 / 10



art.nr.:
LCL534BT

48W

3600 Lm	3000K ~ 6500K	AC 180-260V	50/60 Hz	120°
IP20	0% 100%	CRI=80	0.5m	-15°C ~ +45°C
	25.000h	20.000	UV free	Hg free
<math><1.0\text{sec}</math>				

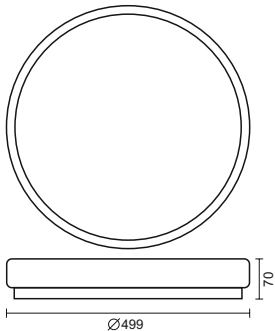

1 / 10



art.nr.:
LCL535BT

36W



1 / 10



art.nr.:
LCL534LW

2700 Lm	3000K ~ 6500K	AC 180-260V	50/60 Hz	120°
IP44	0% 100%	CRI=80	0.5m	-15°C ~ +45°C
25.000h	20.000	UV free	Hg free	
<1.0sec				

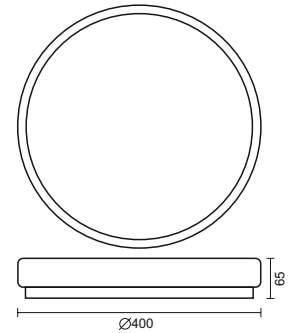

48W



1 / 10



art.nr.:
LCL535LW

3600 Lm	3000K ~ 6500K	AC 180-260V	50/60 Hz	120°
IP44	0% 100%	CRI=80	0.5m	-15°C ~ +45°C
25.000h	20.000	UV free	Hg free	
<1.0sec				

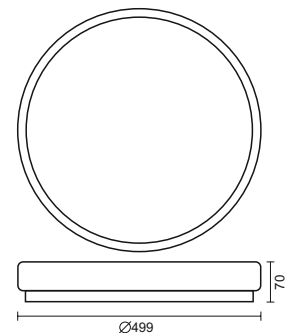

36W

2700 Lm	3000K ~ 6500K	AC 180-260V	50/60 Hz	120°
IP44	0% 100%	CRI=80	0.5m	-15°C ~ +45°C
25.000h	20.000	UV free	Hg free	
<1.0sec				

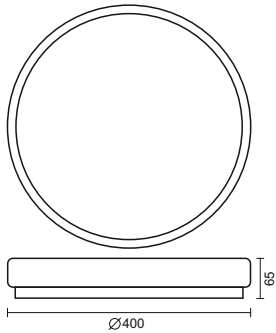

1 / 10



art.nr.:
LCL554B

48W

3600 Lm	3000K ~ 6500K	AC 180-260V	50/60 Hz	120°
IP44	0% 100%	CRI=80	0.5m	-15°C ~ +45°C
25.000h	20.000	UV free	Hg free	
<1.0sec				

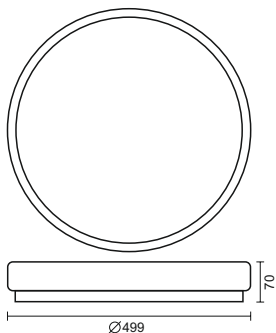

1 / 10



art.nr.:
LCL555B

48W
18W



art.nr.:
LCL6340



1/2

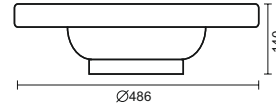
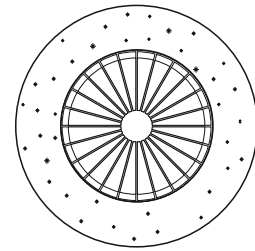

3600 Lm	3000K ~ 6500K	AC 220-240V	50/60 Hz	120°
IP20	0% 100%	CRI=80	0.5m	-15°C ~ +45°C
	25.000h	20.000	UV free	Hg free
	<1.0sec			

48W
18W



art.nr.:
LCL6341



1/2

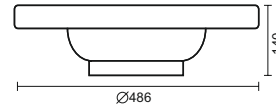
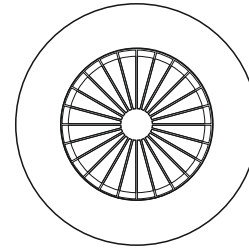

3600 Lm	3000K ~ 6500K	AC 220-240V	50/60 Hz	120°
IP20	0% 100%	CRI=80	0.5m	-15°C ~ +45°C
	25.000h	20.000	UV free	Hg free
	<1.0sec			

48W
18W



art.nr.:
LCL6342



1/2

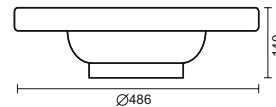
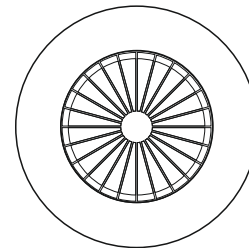

3600 Lm	3000K ~ 6500K	AC 220-240V	50/60 Hz	120°
IP20	0% 100%	CRI=80	0.5m	-15°C ~ +45°C
	25.000h	20.000	UV free	Hg free
	<1.0sec			

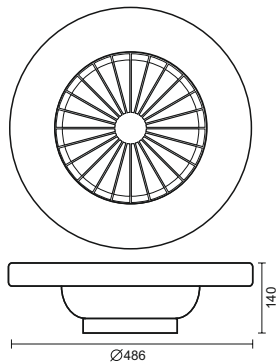
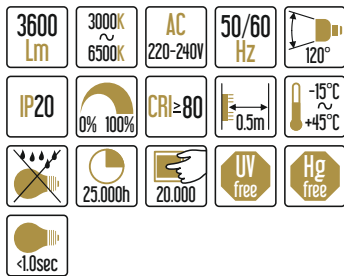

1/2



art.nr.
LCL6343

48W
18W

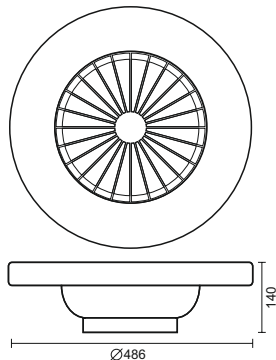
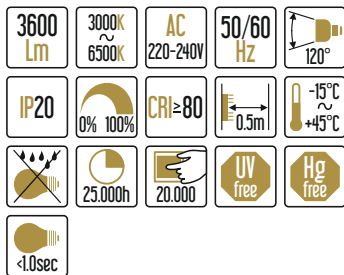

1/2



art.nr.
LCL6344

48W
18W

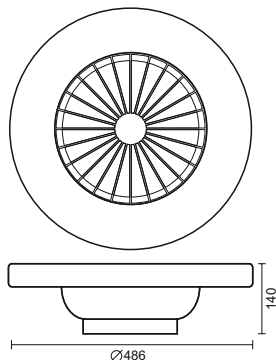
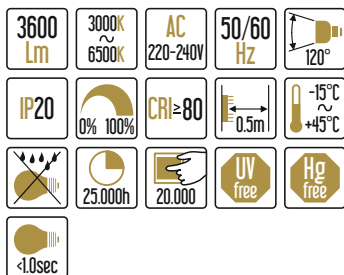

1/2



art.nr.
LCL6345

48W
18W

48W
18W



art.nr.:
LCL6346



1/2



3600 Lm	3000K ~ 6500K	AC 220-240V	50/60 Hz	120°
IP20	0% 100%	CRI=80	0.5m	-15°C ~ +45°C
	25.000h	20.000	UV free	Hg free
	<1.0sec			

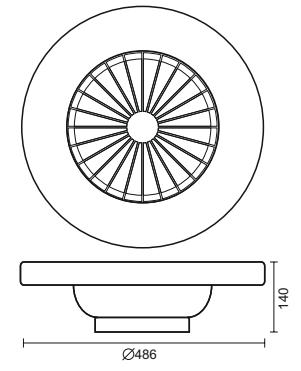

48W
18W



art.nr.:
LCL6347



1/2



3600 Lm	3000K ~ 6500K	AC 220-240V	50/60 Hz	120°
IP20	0% 100%	CRI=80	0.5m	-15°C ~ +45°C
	25.000h	20.000	UV free	Hg free
	<1.0sec			

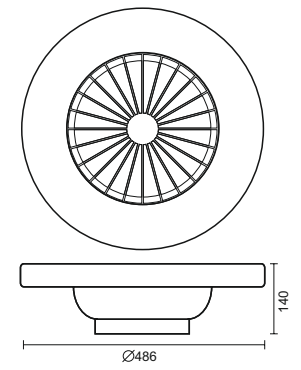

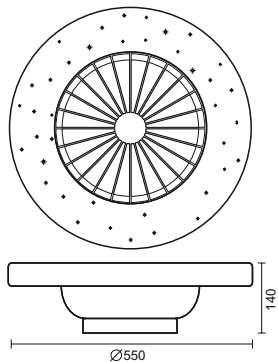
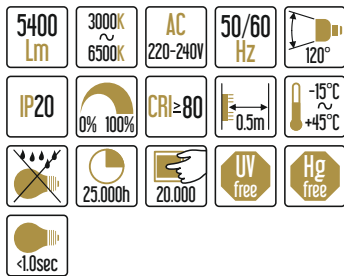

1/2



art.nr.
LCL6350

72W
25W

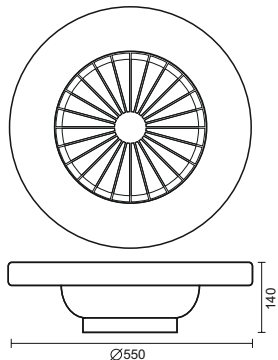
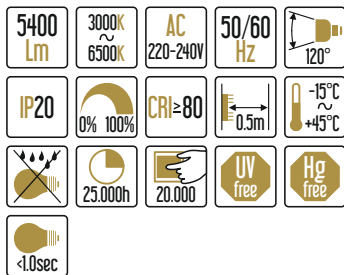

1/2



art.nr.
LCL6351

72W
25W

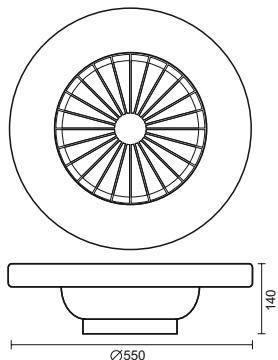
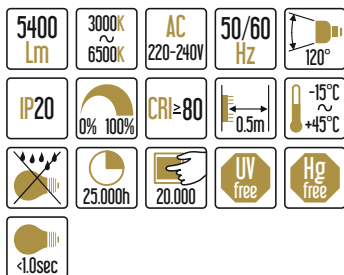

1/2



art.nr.
LCL6352

72W
25W

12W



art.nr.:
LPL522

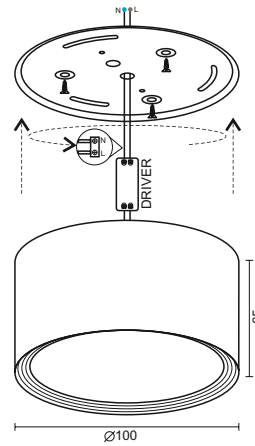

1020 Lm	4000K	AC 110-265V	50/60 Hz	CRI ≥ 80
IP20	0% 100%	0% 100%	120°	-5°C +40°C
30.000h	20.000	UV free	Hg free	<1.0sec
0.5m				

14W



art.nr.:
LPL523

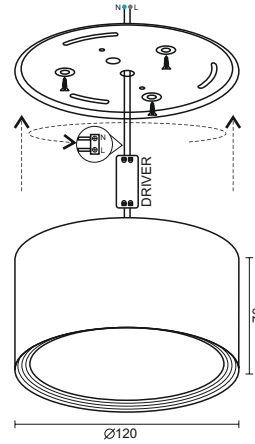

1250 Lm	4000K	AC 110-265V	50/60 Hz	CRI ≥ 80
IP20	0% 100%	0% 100%	120°	-5°C +40°C
30.000h	20.000	UV free	Hg free	<1.0sec
0.5m				

17W



art.nr.:
LPL524

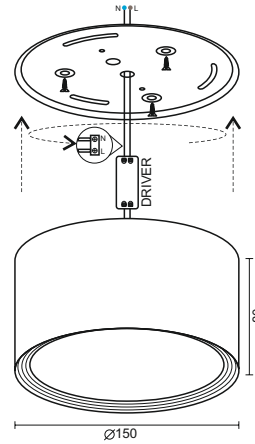

1500 Lm	4000K	AC 110-265V	50/60 Hz	CRI ≥ 80
IP20	0% 100%	0% 100%	120°	-5°C +40°C
30.000h	20.000	UV free	Hg free	<1.0sec
0.5m				

12W

1020 Lm	4000K	AC 110-265V	50/60 Hz	CRI ≥ 80
IP20				
30.000h		UV free	Hg free	

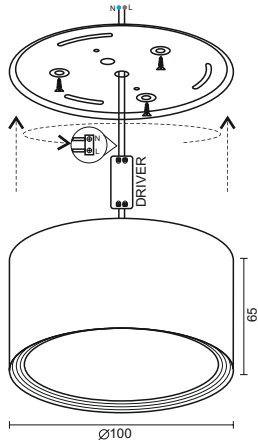

1 / 60



art.nr.:
LPL522B

14W

1250 Lm	4000K	AC 110-265V	50/60 Hz	CRI ≥ 80
IP20				
30.000h		UV free	Hg free	

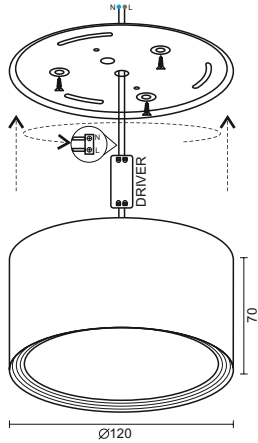

1 / 30



art.nr.:
LPL523B

17W

1500 Lm	4000K	AC 110-265V	50/60 Hz	CRI ≥ 80
IP20				
30.000h		UV free	Hg free	

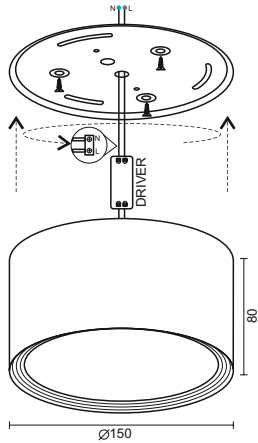

1 / 24



art.nr.:
LPL524B

12W



CRI >= 90



art.nr.:
LPL522C



1/60

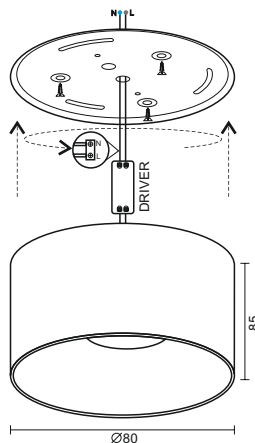

800Lm (90°)	800Lm (cuse)	900Lm (TOTAL)	4000K	AC 110-265V
IP20	0% 100%	24°	50/60 Hz	-5°C +40°C
30.000h	20.000	UV free	Hg free	<1.0sec
	0.5m			

12W



CRI >= 90



art.nr.:
LPL522CB



1/60

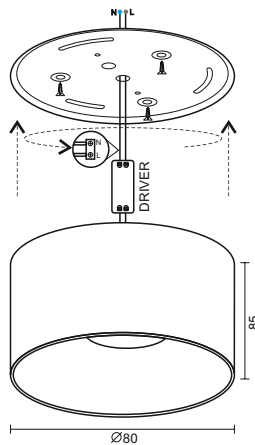

800Lm (90°)	800Lm (cuse)	900Lm (TOTAL)	4000K	AC 110-265V
IP20	0% 100%	24°	50/60 Hz	-5°C +40°C
30.000h	20.000	UV free	Hg free	<1.0sec
	0.5m			

LENS



USED FOR:
LPL522C
LPL522CB

1/1

art.nr.:
L51015



LENS



USED FOR:
LPL522C
LPL522CB

1/1

art.nr.:
L51036



LENS



USED FOR:
LPL522C
LPL522CB

1/1

art.nr.:
L51050



16W

1200Lm (90°)	1200Lm (Φuse)	1350Lm (TOTAL)	4000K	AC 110-265V
IP20				50/60 Hz
		UV free	Hg free	-5°C ~ +40°C
<1.0sec				

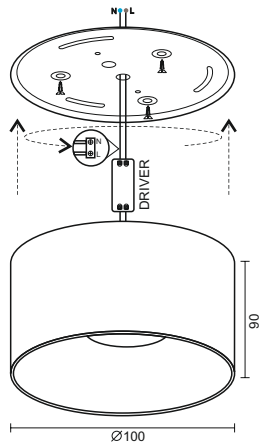

CRI ≥ 90



8 585040 911153



F

art.nr.:
LPL523C

16W

1200Lm (90°)	1200Lm (Φuse)	1350Lm (TOTAL)	4000K	AC 110-265V
IP20				50/60 Hz
		UV free	Hg free	-5°C ~ +40°C
<1.0sec				

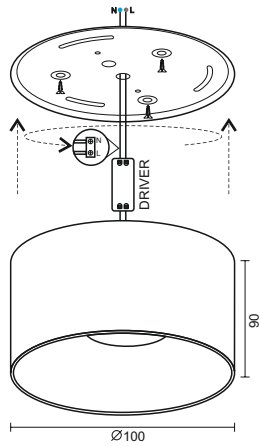

CRI ≥ 90



8 585040 911152



F

art.nr.:
LPL523CB



USED FOR:
LPL523C
LPL523CB

1/1



8 585040 911223

art.nr.:
L51550

www.nedes.eu

LENS



USED FOR:
LPL523C
LPL523CB

1/1



8 585040 911216

art.nr.:
L51536

LENS



USED FOR:
LPL523C
LPL523CB

1/1



8 585040 911209

art.nr.:
L51515

LENS

7.5W



art.nr.:
LDL321



7.5W



art.nr.:
LDL321WB



490 Lm	4000K	AC 165-265V	50/60 Hz	120°
IP20	30.000h	20.000	CRI ≥ 80	0% 100%
Waterproof	0.5m	0.2m	-5°C ~ +40°C	<1.0sec
UV free	Hg free			

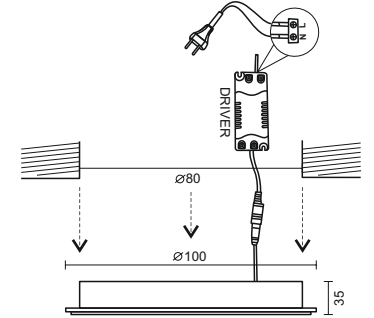

7.5W



art.nr.:
LDL321WS



7.5W



art.nr.:
LDL321WG



490 Lm	4000K	AC 165-265V	50/60 Hz	120°
IP20	30.000h	20.000	CRI ≥ 80	0% 100%
Waterproof	0.5m	0.2m	-5°C ~ +40°C	<1.0sec
UV free	Hg free			

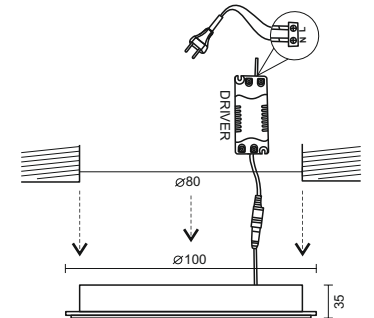

490 Lm	4000K	AC 165-265V	50/60 Hz	120°
IP20	30.000h	20.000	CRI ≥ 80	0% 100%
	0.5m	0.2m	-5°C ~ +40°C	<1.0sec
UV free	Hg free			

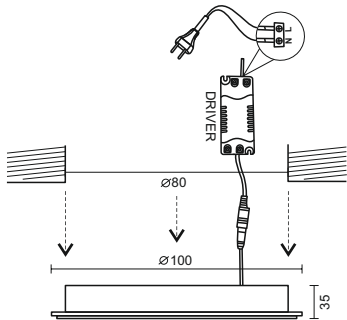

7.5W



art.nr.
LDL321B

490 Lm	4000K	AC 165-265V	50/60 Hz	120°
IP20	30.000h	20.000	CRI ≥ 80	0% 100%
	0.5m	0.2m	-5°C ~ +40°C	<1.0sec
UV free	Hg free			

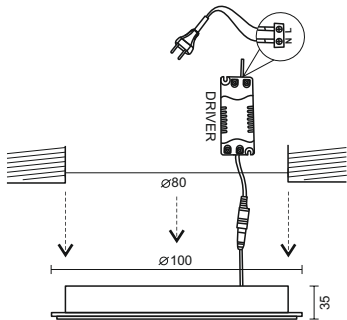

7.5W



art.nr.
LDL321BG

7.5W



art.nr.
LDL321BS

7W



- 3000K
- 590Lm (total)
- 510Lm (Φuse)
- IP44

F
art.nr.:
LDL143



7W



- 4000K
- 620Lm (total)
- 520Lm (Φuse)
- IP44

F
art.nr.:
LDL153



AC 180-265V	50Hz	120°	CRI ≥ 80	0% 100%
V0	30.000h	20.000	-15°C +55°C	<1.0sec
Light bulb icon	0.5m	0.2m	UV free	Hg free

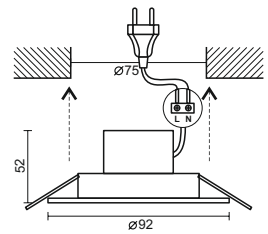

7W



- 3000K
- 590Lm (total)
- 510Lm (Φuse)
- IP44

F
art.nr.:
LDL143/S



7W



- 4000K
- 620Lm (total)
- 520Lm (Φuse)
- IP44

F
art.nr.:
LDL153/S



AC 180-265V	50Hz	120°	CRI ≥ 80	0% 100%
V0	30.000h	20.000	-15°C +55°C	<1.0sec
Light bulb icon	0.5m	0.2m	UV free	Hg free

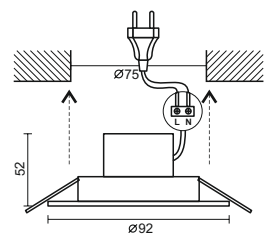

7W



- 4000K
- 620Lm (total)
- 520Lm (Φuse)
- IP44

F
art.nr.:
LPL153/B



7W



- 4000K
- 620Lm (total)
- 520Lm (Φuse)
- IP44

F
art.nr.:
LPL153/WL



AC 180-265V	50Hz	120°	CRI ≥ 80	0% 100%
V0	30.000h	20.000	-15°C +55°C	<1.0sec
Light bulb icon	0.5m	0.2m	UV free	Hg free

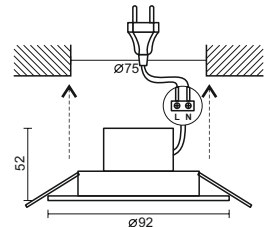

870Lm (total)	730Lm (Φuse)	4000K	AC 180-265V	50Hz
VO	30.000h	120°	CRI ≥ 80	0% 100%
0.5m	20.000	-15°C +55°C	<1.0sec	
0.2m	UV free	Hg free		

IP44

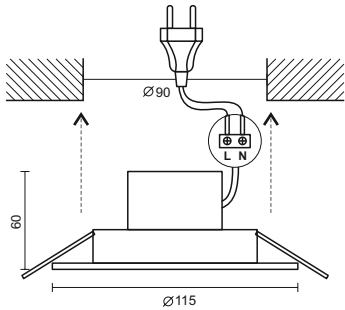

1 / 50

8 585040 904362

F

art.nr.:
LDL154

870Lm (total)	730Lm (Φuse)	4000K	AC 180-265V	50Hz
VO	30.000h	120°	CRI ≥ 80	0% 100%
0.5m	20.000	-15°C +55°C	<1.0sec	
0.2m	UV free	Hg free		

IP44

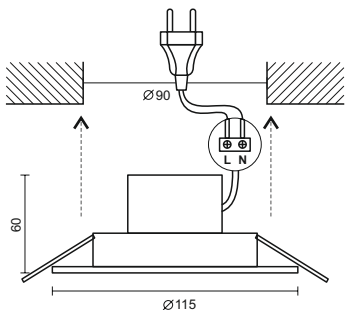

1 / 50

8 585040 904379

F

art.nr.:
LDL154/S

7W



IP44

580Lm (total)	510Lm (fuse)	4000K	AC 180-265V	50Hz
	30.000h	120°	CRI ≥ 80	0% 100%
	0.5m	20.000	-15°C +55°C	<1.0sec
0.2m	UV free	Hg free		

F

art.nr.:
LDL253

1/100

8 585040 904072

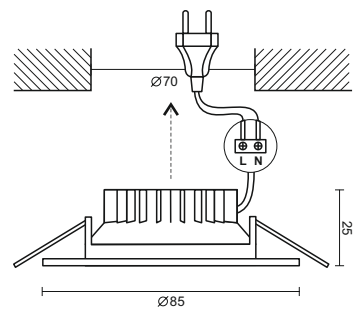

7W



IP44

580Lm (total)	510Lm (fuse)	4000K	AC 180-265V	50Hz
	30.000h	120°	CRI ≥ 80	0% 100%
	0.5m	20.000	-15°C +55°C	<1.0sec
0.2m	UV free	Hg free		

F

art.nr.:
LPL253/S

1/100

8 585040 904089

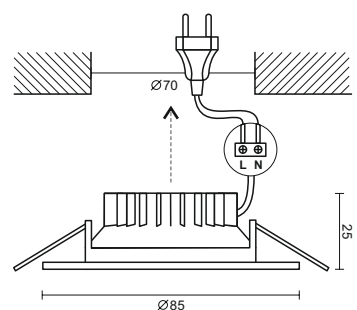

560Lm (90°)	560Lm (Φuse)	4000K	AC 85-265V	50/60 Hz
IP20	30.000h	20.000	55°	<1.0sec
		-5°C ~ +40°C	UV free	Hg free
0.5m	0.2m			

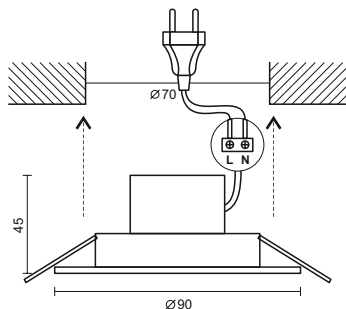

CRI>90

1 / 100

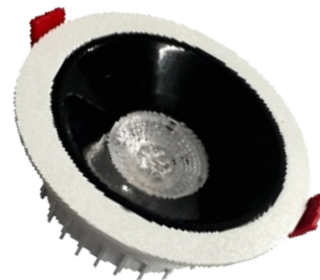

F
art.nr.:
LDL721

7W



USED FOR:
LDL721

1 / 1



art.nr.:
L70736

LENS



USED FOR:
LDL721

1 / 1



art.nr.:
L70724

LENS



USED FOR:
LDL721

1 / 1



art.nr.:
L70715

LENS



840Lm (90°)	840Lm (Φuse)	4000K	AC 85-265V	50/60 Hz
IP20	30.000h	20.000	55°	<1.0sec
		-5°C ~ +40°C	UV free	Hg free
0.5m	0.2m			

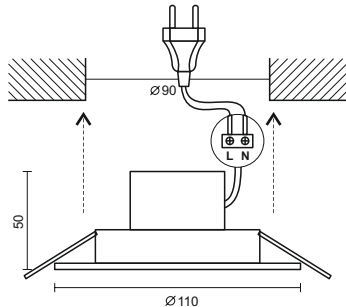

CRI>90

1 / 50



F
art.nr.:
LDL722

11.5W



USED FOR:
LDL722

1 / 1



art.nr.:
L71236

LENS



USED FOR:
LDL722

1 / 1



art.nr.:
L71224

LENS



USED FOR:
LDL722

1 / 1



art.nr.:
L71215

LENS



9W



F

art.nr.:
LNL822

1/25



950Lm (360°)	4000K	AC 175-265V	50Hz	CRI ≥ 80
IP20	IK08		0% 100%	-5°C +45°C
UV free	Hg free	30.000h	25.000	180°
<1.0sec				

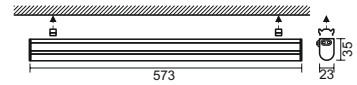
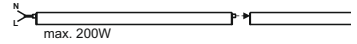

12W



F

art.nr.:
LNL823

1/25



1250Lm (360°)	4000K	AC 175-265V	50Hz	CRI ≥ 80
IP20	IK08		0% 100%	-5°C +45°C
UV free	Hg free	30.000h	25.000	180°
<1.0sec				

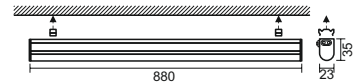

CABLE

100cm



1/500



art.nr.:
WLF201

EXTENSION

15cm



1/500



art.nr.:
WLF211

AC 250V	IP20	350W	1.5A	2x 0.5mm
------------	------	------	------	-------------

9W

900Lm (360°)	4000K	AC 180-265V	50Hz	CRI≥80
IP40	IK08			-25°C +65°C
UV free	Hg free	35.000h	30.000	120°
	<1.0sec			

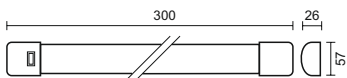

1 / 50



art.nr.:
LNL121/1

18W

1850Lm (360°)	4000K	AC 180-265V	50Hz	CRI≥80
IP40	IK08			-25°C +65°C
UV free	Hg free	35.000h	30.000	120°
	<1.0sec			

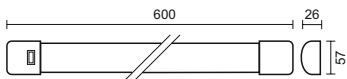

1 / 50



art.nr.:
LNL122/1

20W



art.nr.:
LNL122/2

1/25



2200Lm (360°)	4000K	AC 180-265V	50Hz	CRI≥80
IP40	IK08		0% 100%	-25°C +65°C
UV free	Hg free	35.000h	30.000	120°
	<1.0sec			

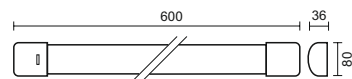

20W



art.nr.:
LNL122/3

1/25



2200Lm (360°)	4000K	AC 180-265V	50Hz	CRI≥80
IP40	IK08		10% 100%	-25°C +65°C
UV free	Hg free	35.000h	30.000	120°
	<1.0sec			

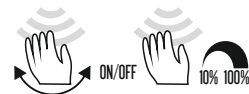
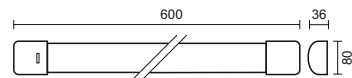

36W

3850Lm (360°)	4000K	AC 180-265V	50Hz	CRI≥80
IP40	IK08			
		35.000h	30.000	
	<1.0sec			

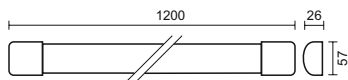

F

art.nr.:
LNL123/1

2700Lm (360°)	4000K	AC 220-240V	50Hz	CRI≥80
IP20				
		20.000h	15.000	
<1.0sec				

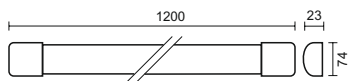

36W

art.nr.:
LNL123A

4300Lm (360°)	4000K	AC 180-265V	50Hz	CRI≥80
IP40	IK08			
		35.000h	30.000	
<1.0sec				



40W

F

art.nr.:
LNL124

72W



art.nr.: LNL125



5800Lm (360°)	4000K	AC 220-240V	50Hz	CRI ≥ 80
IP20	0% 100%	-5°C ~ +45°C	120°	
UV free	Hg free	20.000h	15.000	<1.0sec

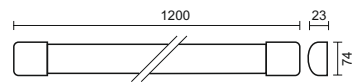

60W



D
art.nr.: LNL126

LIFUD
LED Driver

SETTABLE POWER
35W / 4800Lm
44W / 6000Lm
52W / 7100Lm
60W / 8200Lm



8200Lm (360°)	4000K	AC 180-265V	50/60 Hz	Pf=0.95
IP20	IK08	-5°C ~ +45°C	CRI ≥ 80	
120°	50.000h	30.000	0% 100%	<1.0sec
UV free	Hg free	0.5m		

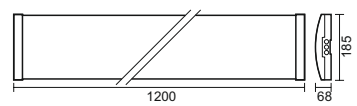

EMER. KIT



USED FOR:
LNL126
1/1



art.nr.: EK126

DIM. DRIVER



USED FOR:
LNL126
1/1



art.nr.: DD126

SENSOR

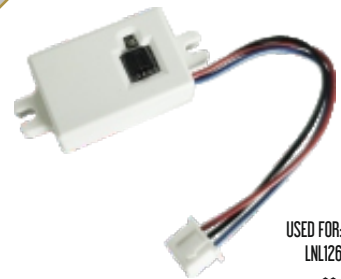

USED FOR:
LNL126
1/1



art.nr.: SM126

REMOTE



USED FOR:
SM126
1/100



art.nr.: RLNL126

40W

5400 Lm	4000K	AC 180-265V	50Hz	CRI≥80
50.000h	30.000		0% 100%	-20°C +65°C
UV free	Hg free	<1.0sec	0.5m	120°

IP69K IK10 **EKOKE**
DRIVER



1 / 15

8 585040 905398

D

art.nr.:
LNL423

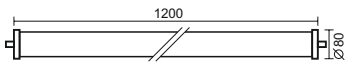

1700 Lm	3000K 4000K 6000K	AC 180-265V	50/60 Hz	CRI≥80
IP44	IK08		0% 100%	-20°C +45°C
UV free	Hg free	30.000h	15.000	150°
<1.0sec	0.5m			

DIMMABLE
+CCT



IP44 French socket MAX.250V~16A



1 / 25

8 585040 916709

E

art.nr.:
LNL7621/WH

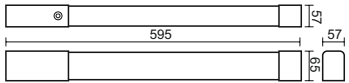

1700 Lm	3000K 4000K 6000K	AC 180-265V	50/60 Hz	CRI≥80
IP44	IK08		0% 100%	-20°C +45°C
UV free	Hg free	30.000h	15.000	150°
<1.0sec	0.5m			

DIMMABLE
+CCT



IP44 EU socket MAX.250V~16A



1 / 25

8 585040 916693

E

art.nr.:
LNL7621/WHE

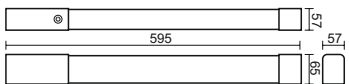

15W



F

art.nr.:
LNL7121/WH

1/50



1500Lm (360°)	4000K	AC 180-265V	50/60 Hz	CRI ≥ 80
IP44	IK08	☔	0% 100%	-20°C +45°C
UV free	Hg free	30.000h	15.000	150°
<1.0sec	0.5m			

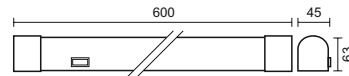

15W



F

art.nr.:
LNL7121/SI

1/50



1500Lm (360°)	4000K	AC 180-265V	50/60 Hz	CRI ≥ 80
IP44	IK08	☔	0% 100%	-20°C +45°C
UV free	Hg free	30.000h	15.000	150°
<1.0sec	0.5m			

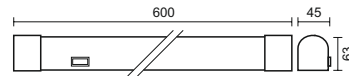

15W



F

art.nr.:
LNL7221/CH

1/50



1500Lm (360°)	4000K	AC 180-265V	50/60 Hz	CRI ≥ 80
IP44	IK08	☔	0% 100%	-20°C +45°C
UV free	Hg free	30.000h	15.000	150°
<1.0sec	0.5m			

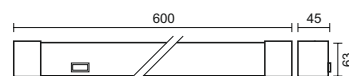

15W

1500 _{Lm} (360°)	4000K	AC 180-265V	50/60 Hz	CRI ≥ 80
IP44	IK08			-20°C +45°C
UV free	Hg free	30.000h	15.000	120°
<1.0sec	0.5m			

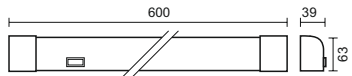

1 / 50



F

art.nr.:
LNL7321/WH

1500 _{Lm} (360°)	4000K	AC 180-265V	50/60 Hz	CRI ≥ 80
IP44	IK08			-20°C +45°C
UV free	Hg free	30.000h	15.000	150°
<1.0sec	0.5m			

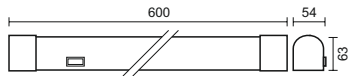

1 / 50



F

art.nr.:
LNL7421/WH

15W

1500 _{Lm} (360°)	4000K	AC 180-265V	50/60 Hz	CRI ≥ 80
IP44	IK08			-20°C +45°C
UV free	Hg free	30.000h	15.000	150°
<1.0sec	0.5m			

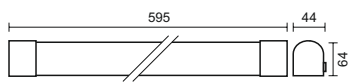

1 / 50



F

art.nr.:
LNL7521/CH

15W

36W



art.nr.:
LNL322

1 / 25



4140Lm (360°)	4000K	AC 180-265V	50Hz	CRI≥80
IP65	IK08			-20°C +65°C
UV free	Hg free	30.000h	20.000	

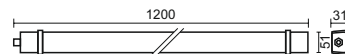

36W



art.nr.:
LNL322/1

1 / 25



4140Lm (360°)	4000K	AC 180-265V	50Hz	CRI≥80
IP65	IK08			-20°C +65°C
UV free	Hg free	30.000h	20.000	

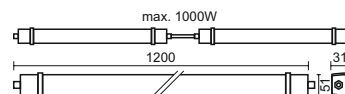

36W

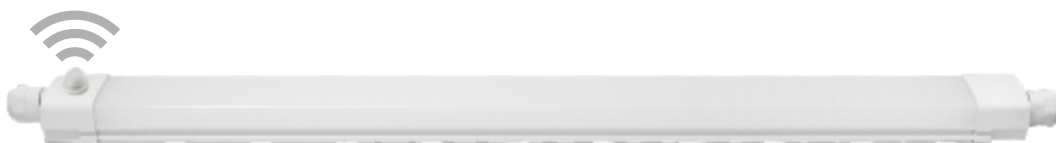

art.nr.:
LNL322/1S

1 / 25



4140Lm (360°)	4000K	AC 180-265V	50Hz	CRI≥80
IP65	IK08			-20°C +65°C
UV free	Hg free	30.000h	20.000	
PIR SENSOR	5Lx±2Lx 4m±1m 15s±5s			

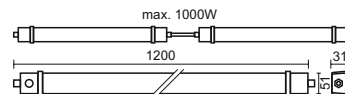

40W

4600Lm (360°)	4000K	AC 180-265V	50Hz	CRI≥80
IP65	IK08			
		35.000h	30.000	120°
	<1.0sec			

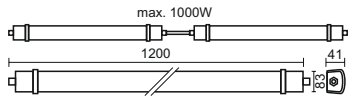

1 / 25

8 585040 902931

E

art.nr.:
LNL323/2

5200Lm (360°)	4000K	AC 180-265V	50Hz	CRI≥80
IP65	IK08			
		50.000h	30.000	120°
	<1.0sec			

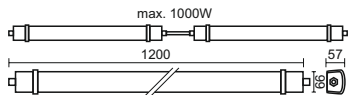

1 / 25

8 585040 904584

E

art.nr.:
LNL324/3

40W

EOKE
DRIVER



6500Lm (360°)	4000K	AC 180-265V	50Hz	CRI≥80
IP65	IK08			
		50.000h	30.000	120°
	<1.0sec			

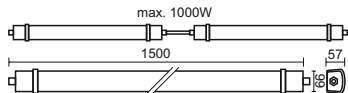

1 / 25

8 585040 905406

E

art.nr.:
LNL325/3

50W

EOKE
DRIVER



40W

BOKE
DRIVER

LEDEmergency
5W/600Lm



D

art.nr.:
LNL324/3E

1 / 20



5800Lm (360°)	4000K	AC 180-265V	50Hz	CRI ≥ 80
IP65	IK08	0% 100%	0% 100%	-25°C +65°C
UV free	Hg free	50.000h	30.000	120°
3h	<1.0sec			

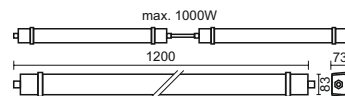

40W

BOKE
DRIVER

MICROSENSOR
5.8GHz/50Hz



D

art.nr.:
LNL324/3S

1 / 20



5800Lm (360°)	4000K	AC 180-265V	50Hz	CRI ≥ 80
IP65	IK08	0% 100%	0% 100%	-20°C +65°C
UV free	Hg free	50.000h	30.000	120°
<1.0sec				

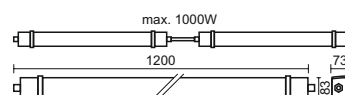

REMOTE



art.nr.:
RLNL324

USED FOR:
LNL324/3S

1 / 100



CR2025	3V
--------	----

metal 250cm



USED FOR:
LNL1.
LNL2..
LNL3..
LNL4..

1 / 100



HANGING

art.nr.:
SNN250

metal 180°



USED FOR:
LNL324/3S
LNL324/3E

1 / 100



CLIPS

art.nr.:
SNR180

metal 180°



USED FOR:
LNL324/3
LNL325/3

1 / 100



CLIPS

art.nr.:
SNR180/1

2xT8



LED TUBES ONLY

G13	2xT8	2x120cm	AC 220-240V	-30°C ~ +55°C
IP20	Hg free	0.5m		

art.nr.: TL102

1 / 10

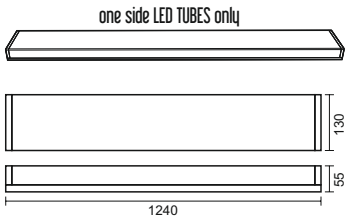

2xT8

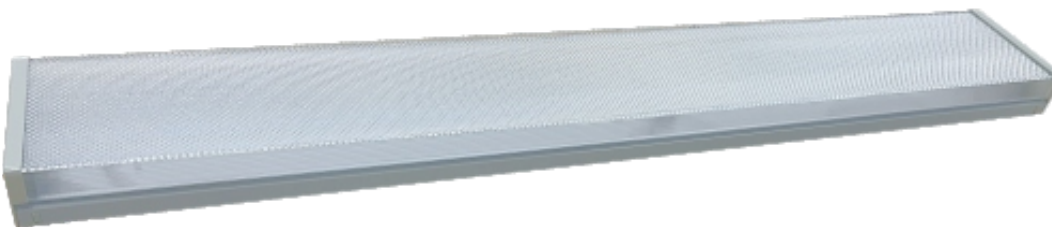

LED TUBES ONLY

G13	2xT8	2x120cm	AC 220-240V	-30°C ~ +55°C
IP20	Hg free	0.5m		

art.nr.: TL103

1 / 8

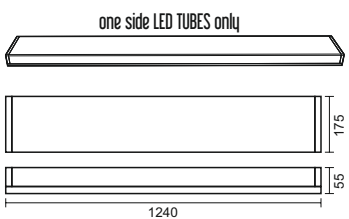

2xT8



LED TUBES ONLY

G13	2xT8	2x120cm	AC 220-240V	-30°C ~ +55°C
IP65	Hg free	0.5m		

art.nr.: TL401

1 / 8

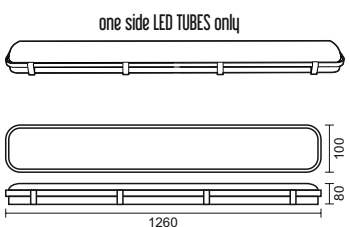



LED TUBES ONLY



1/4



art.nr.: TL301B

LED TUBES ONLY



1/4



art.nr.: TL301



one side LED TUBES only

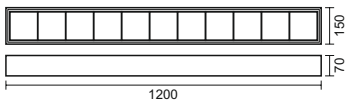

LED TUBES ONLY



1/4



art.nr.: TL302B

LED TUBES ONLY



1/4



art.nr.: TL302

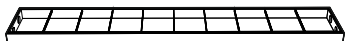

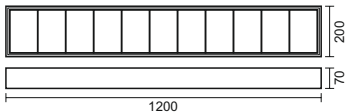

one side LED TUBES only



2xT8

LED TUBES ONLY

 G13	2xT8	 2x120cm	AC 220-240V	 -30°C ~ +55°C
IP20	 Hg free	 0.5m		



art.nr.: TL203

1/2 



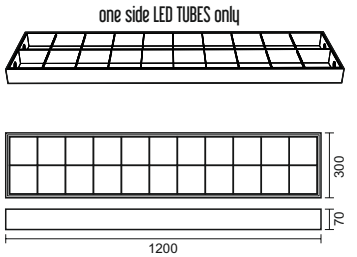

8 585040 913791



2xT8

LED TUBES ONLY

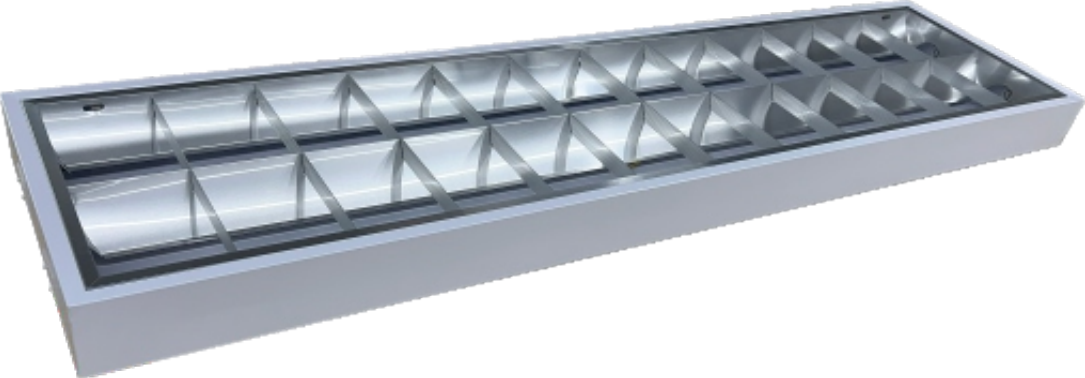
 G13	2xT8	 2x120cm	AC 220-240V	 -30°C ~ +55°C
IP20	 Hg free	 0.5m		



art.nr.: TL303

1/1 



8 585040 913593

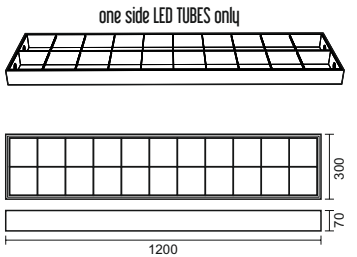

metal 100cm

USED FOR:
TL

1 / 20



art.nr.:
HF01

HOLDER

metal 100cm

USED FOR:
TL

1 / 20



art.nr.:
HF02B

USED FOR:
TL

1 / 20



art.nr.:
HF02

HOLDER

metal 50-100 cm

USED FOR:
TL

1 / 20



art.nr.:
HF03B

USED FOR:
TL

1 / 20



art.nr.:
HF03

HOLDER

metal 75-150 cm

USED FOR:
TL

1 / 20



art.nr.:
HF04B

USED FOR:
TL

1 / 20



art.nr.:
HF04

HOLDER

5W



HAZEL
art.nr.:
DL1201/W



350 Lm	4000K	AC 100-240V	DIMMABLE	Ra ≥ 80
IP20		50/60 Hz	<1.0sec	-5°C ~ +40°C
30.000h	20.000	UV free	Hg free	0.1m
1.4m				

1 / 12

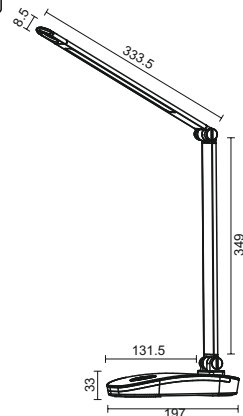

5W



LISA
art.nr.:
DL1202/W



300 Lm	4000K	AC 100-240V	DIMMABLE	Ra ≥ 80
IP20		50/60 Hz	<1.0sec	-5°C ~ +40°C
30.000h	20.000	UV free	Hg free	0.1m
1.4m				

1 / 12

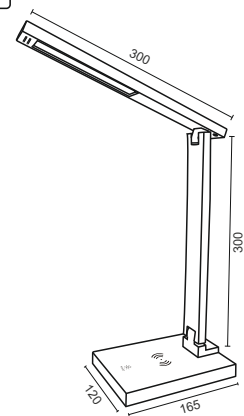

8W

400 Lm	4000K	AC 100-240V	DIMMABLE	Ra ≥ 80
IP20		50/60 Hz	<1.0sec	-5°C ~ +40°C
30.000h	20.000	UV free	Hg free	0.1m
1.4m				

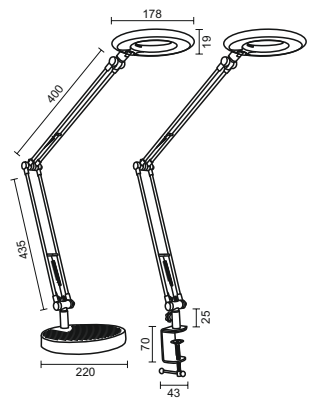

1/4



BIANCA
art.nr.:
DL1203/B

5W

250 Lm	4000K	AC 100-240V	DIMMABLE	Ra ≥ 80
IP20		50/60 Hz	<1.0sec	-5°C ~ +40°C
30.000h	20.000	UV free	Hg free	0.1m
1.0m				

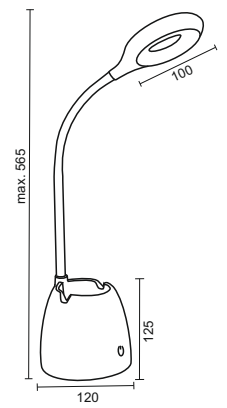

1/12



ALEXA
art.nr.:
DL1204/W

5W



ALICE
art.nr.:
DL1205/W



300 Lm	4000K	AC 100-240V	DIMMABLE	Ra ≥ 80
IP20		50/60 Hz		-5°C ~ +40°C
30.000h		UV free	Hg free	0.1m
1.4m				

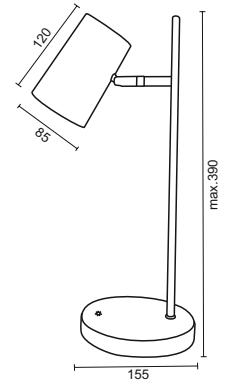

5W



AMY
art.nr.:
DL1207/W



300 Lm	4000K	AC 100-240V	DIMMABLE	Ra ≥ 80
IP20		50/60 Hz		-5°C ~ +40°C
30.000h		UV free	Hg free	0.1m
1.4m				

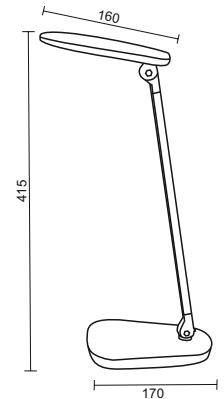

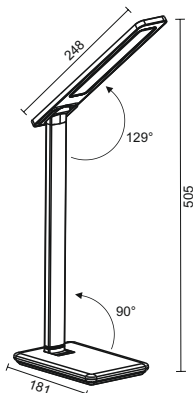
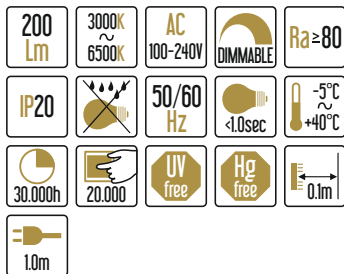

JOY
art.nr.:
DL2301/W



6W



JOY
art.nr.:
DL2301/B



6W

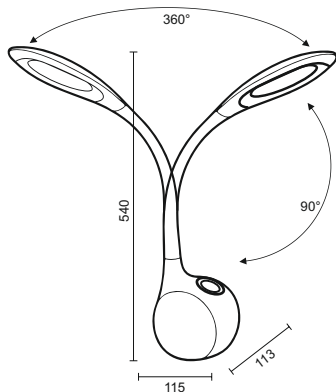
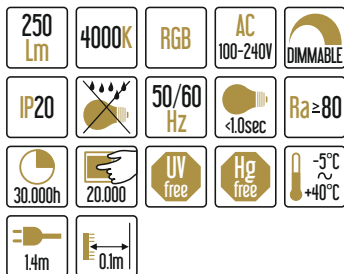

EMILY
art.nr.:
DL3401/W



7W

8W



MEGGIE
art.nr.:
DL3304/W



550 Lm	3000K ~ 6500K	AC 100-240V	DIMMABLE	Ra ≥ 80
IP20		50/60 Hz	<1.0sec	-5°C ~ +40°C
30.000h		UV free	Hg free	0.1m
1.7m				

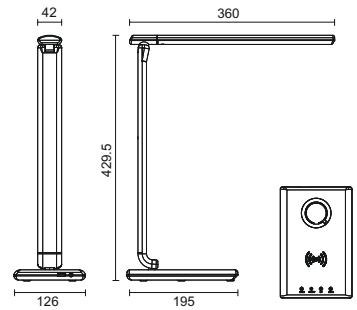

7W



OCTAVIA
art.nr.:
DL4301/B



350 Lm	3000K ~ 6500K	AC 100-240V	DIMMABLE	Ra ≥ 80
IP20		50/60 Hz	<1.0sec	-5°C ~ +40°C
30.000h		UV free	Hg free	0.1m
1.4m				



OCTAVIA
art.nr.:
DL4301/W

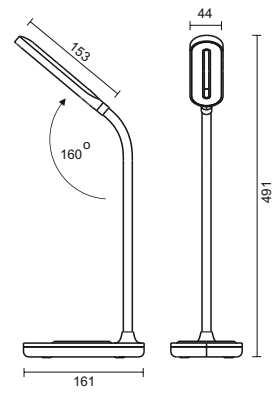

7W

350 Lm	3000K ~ 6500K	AC 100-240V	DIMMABLE	Ra ≥ 80
IP20		50/60 Hz	 <1.0sec	-5°C ~ +40°C
 30.000h	 20.000	UV free	Hg free	 0.1m
 1.4m				

 ALARM	 TIME	 TEMPER.
-----------	----------	-------------

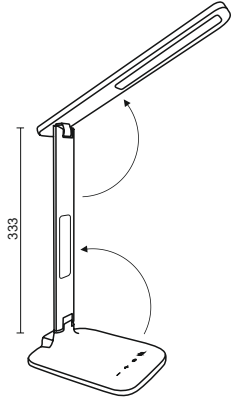

NAOMI
art.nr.:
DL4303/W

500 Lm	3000K ~ 6500K	AC 100-240V	DIMMABLE	Ra ≥ 80
IP20		50/60 Hz	 <1.0sec	-5°C ~ +40°C
 30.000h	 20.000	UV free	Hg free	 0.1m
 1.4m				

 CHARGING	 AUTO OFF	NIGHT LIGHT
--------------	--------------	----------------

7W

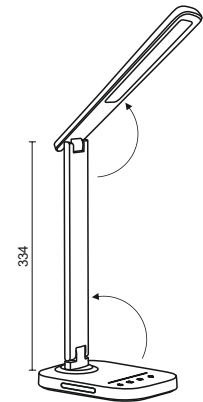

KIARA
art.nr.:
DL4304/W

 CHARGING	 AUTO OFF	NIGHT LIGHT
--------------	--------------	----------------

7W



KIARA
art.nr.:
DL4304/B

8W



JENY
art.nr.:
DL4305/B



400 Lm	3000K ~ 6500K	AC 100-240V	DIMMABLE	Ra ≥ 80
IP20		50/60 Hz	<1.0sec	-5°C ~ +40°C
30.000h		UV free	Hg free	0.1m
	1.4m			



1 / 12

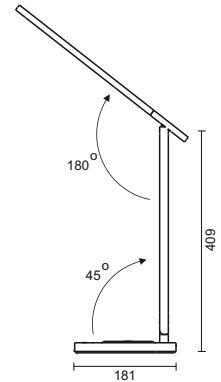

12W



XENIA
art.nr.:
DL4306/B



800 Lm	3000K ~ 6500K	AC 100-240V	DIMMABLE	Ra ≥ 80
IP20		50/60 Hz	<1.0sec	-5°C ~ +40°C
30.000h		UV free	Hg free	0.1m
	1.7m			



1 / 4

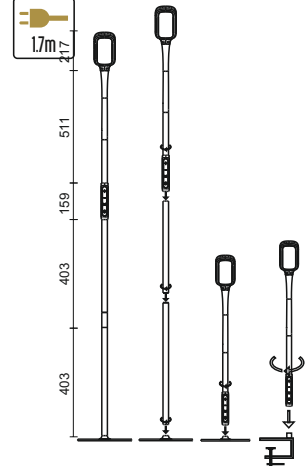

8W

400 Lm	4000K	AC 100-240V	DIMMABLE	Ra ≥ 80
IP20		50/60 Hz	 <1.0sec	-5°C ~ +40°C
 30.000h	 20.000	UV free	Hg free	 0.1m
 1.4m				

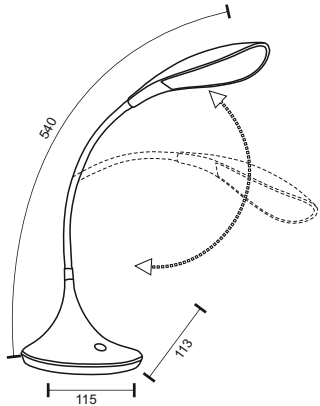

1 / 6



ADDISON
art.nr.:
DL3205/W

10W

750 Lm	4000K	AC 100-240V	DIMMABLE	Ra ≥ 80
IP20		50/60 Hz	 <1.0sec	-5°C ~ +40°C
 30.000h	 20.000	UV free	Hg free	 0.1m
 1.7m				

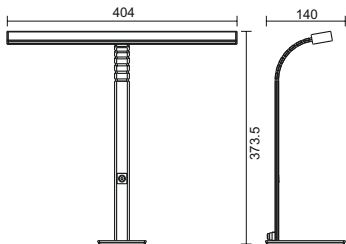

1 / 6



AMELIA
art.nr.:
DL5301/S

12W



500 Lm	3000K ~ 6500K	AC 100-240V	DIMMABLE	Ra ≥ 80
IP20		50/60 Hz		-5°C ~ +40°C
30.000h		UV free	Hg free	0.1m

FRIDA
art.nr.:
DL5302/B

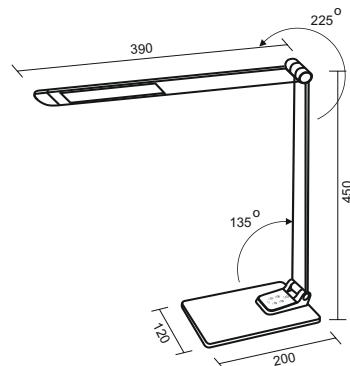

12W



500 Lm	3000K ~ 6500K	AC 100-240V	DIMMABLE	Ra ≥ 80
IP20		50/60 Hz		-5°C ~ +40°C
30.000h		UV free	Hg free	0.1m

JULIET
art.nr.:
DL5303/B

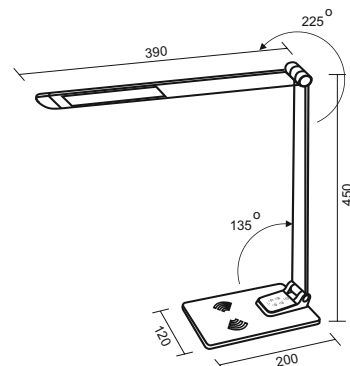

1000 Lm	RGBIC +W	3000K ~ 6500K	AC 220-240V	DIMMABLE
IP20		50/60 Hz	 <1.0sec	Ra ≥ 80
 30.000h	 20.000	UV free	Hg free	 -5°C ~ +40°C
 2m	 0.1m			

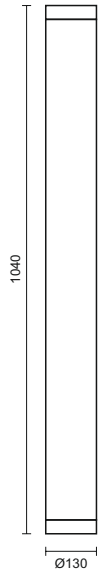

1/4



8 585040 912763



ATMOSPHERE

art.nr.:
DL6401



art.nr.:
FCL01



1/6/24



60 Lm	IPX4	WHITE LED	RED LED	
4xAA	1.5V	<1.0sec	UV free	Hg free
MODE 100%/50%/RED/OFF				

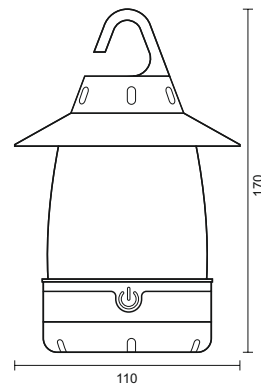

art.nr.:
FCL02



1/8/32



10 Lm	IPX4	1W CREE	RED LED	
1xD	1.5V	<1.0sec	UV free	Hg free
MODE CREE 100%/RED/OFF				

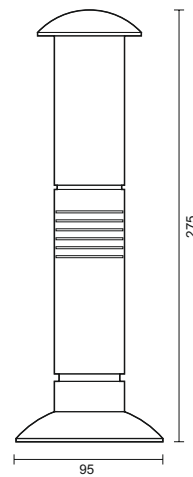

10W

10W SMD	850 Lm	IP44		FOCUS
Li-ion	4000mAh	SMD-3h		DISPLAY INDICATOR
UV free	Hg free	5V/1A		POWER BANK

MODE
100% SMD / 40% SMD / 15% SMD / * / OFF



1 / 20



art.nr.:
FLO4R

3W SMD	3W COB	200 +120um	IP44	
Li-ion	800mAh	SMD-2h	COB-3.5h	3h

MODE
100% SMD / 30% SMD / 100% COB / 100% COB / * / OFF



3+3W

1 / 20 / 40



art.nr.:
FLO5R

8+2W



8W SMD	2W COB	650 Lm	IPX4	
Li-ion	1200mAh	SMD-3/4h	COB-2.5h	
5V/1A	50cm	FOCUS	UV free	Hg free

MODE 100%SMD/55%SMD/30%SMD/☀/SOS/OFF
100%COB/30%COB/●COB/☀/●COB/OFF

art.nr.:
FLO6R

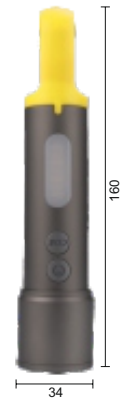

1W



1W SMD	5x SMD	50Lm	IP44	
Li-Po	400mAh	SMD-5.5h	5SMD-3.5h	1.5h
5V/1A	30cm	UV free	Hg free	

MODE 100%SMD/30%SMD/☀/●/100%5SMD/30%5SMD/OFF

art.nr.:
FLO7R

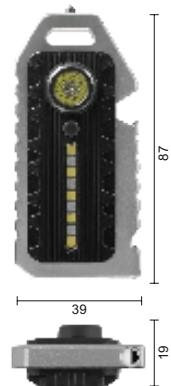

5-3W

5W CREE	3W COB	6000K	350+ 150Lm	IP65
Li-ion	4000mAh	CREE-3h	7h	POWER BANK
5V/1A	60cm	Hg free	POWER INDICATOR	
MODE	100% CREE / 50% CREE / OFF ○ COB / ● COB / ✱ COB / OFF			400m



1 / 4 / 16



art.nr.:
FS03R

5-1W

5W COB	1W SMD	6000K	600+ 80Lm	IPX4
Li-ion	1800mAh	SMD-10h	COB-3h	3h
UV free	5V/1A	100cm	Hg free	Hg free
MODE	100% SMD / 100% COB / SMD / OFF			



1 / 20 / 40



art.nr.:
WL01R

10W

10W COB	6000K	400 Lm	IPX4	0% 100%
Li-ion	2000mAh	SMD-10h	10W-3h	4h
UV free	Hg free	POWER INDICATOR		
MODE	30% COB / 100% COB / LED / OFF			



1 / 15 / 45



art.nr.:
WL03R

5+3W



art.nr.:
WL09R



5W COB	3W SMD	350+ 70Lm	IP44	
Li-ion	1200mAh	SMD-7h	COB-3h	
MODE 30%COB/100%COB/ONSMD/OFF				
	POWER INDICATOR	UV free	Hg free	



15W



art.nr.:
WL10R



1000 Lm			IPX4	
Li-ion	2000mAh	15W-3h		POWER INDICATOR
MODE 100%/35%/OFF			UV free	Hg free



3W COB	1W SMD	310+230+60 Lm	POWER BANK
Li-ion	2000mAh	SMD-17.5h	COB-7h
IPX4			
	5V/1A	50cm	POWER INDICATOR
MODE	100% COB / 25% COB / 0NSMD / 100% COB 20% COB / COB / COB / OFF		
	UV free	Hg free	

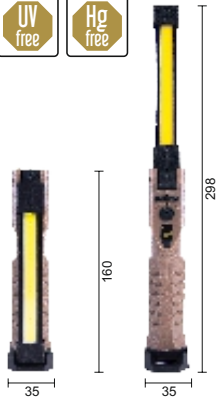

1 / 20 / 40



art.nr:
WL11R

800 Lm	IP54			
Li-ion	2200mAh	10W-2h	4h	POWER INDICATOR
MODE	100%/50%/OFF			
	UV free	Hg free		

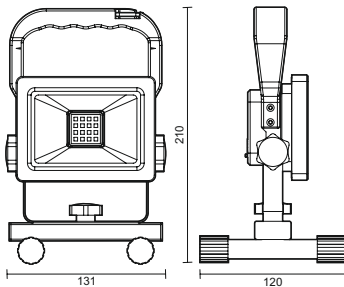

1 / 20



art.nr:
WL20R

10W

20W

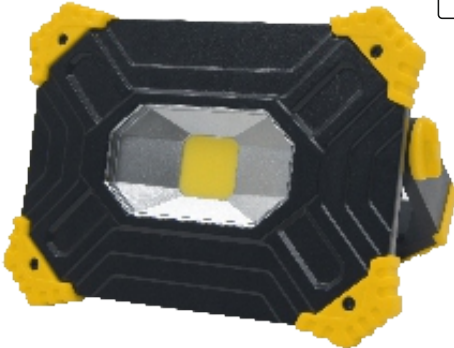

- 1000 Lm
- 4400mAh
- 4h

art.nr.: WL21R

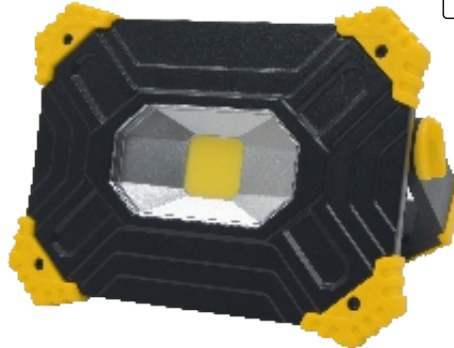

- 2000 Lm
- 6600mAh
- 5.5h

art.nr.: WL22R



- COB
- IP54
- 5V/2A
- 100cm
- Li-ion
- 2h
- POWER BANK
- POWER INDICATOR
- MODE 100%/50%/OFF
- UV free
- Hg free

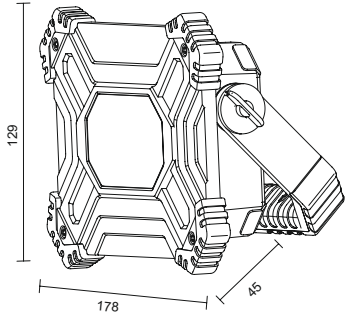

30W



art.nr.: WL24R



- 3000 Lm
- IP54
- 5V/2A
- 100cm
- Li-ion
- 6600mAh
- 30W-2h
- 5.5h
- POWER INDICATOR
- MODE 100%/50%/10%/OFF
- UV free
- Hg free

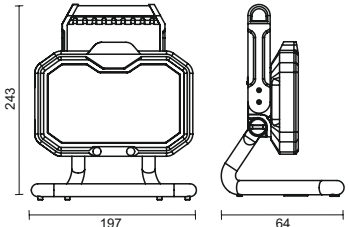

30W

3000 Lm	IP54		5V/2A	100cm
Li-ion	6600mAh	30W-2h	5.5h	POWER INDICATOR
MODE 100%/50%/10%/OFF	UV free	Hg free		

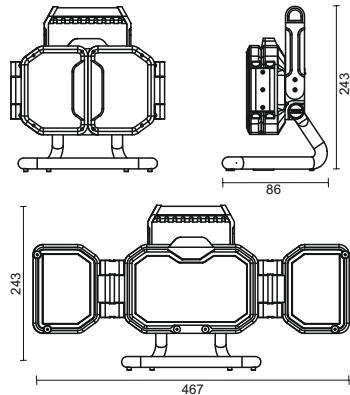

1/6



art.nr.
WL25R

50W

5000 Lm	IP54		5V/2A	100cm
Li-ion	12000mAh	50W-2h	10h	POWER INDICATOR
MODE 100%/50%/10%/OFF	UV free	Hg free		

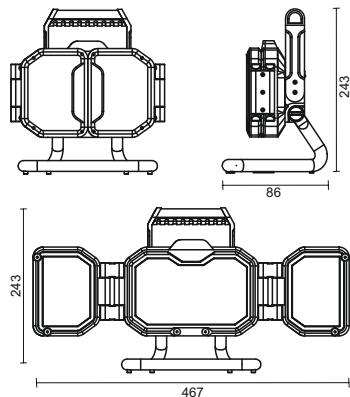

1/6



art.nr.
WL26R

5W



5W XPG2	230 Lm	6000K	IP66	
Li-Pol	1200mAh	5W-4h	3h	IR SENSOR
5V/1A	30cm	MODE 100%/50%/20%/OFF 3sec SOS		
UV free	Hg free			



art.nr.: LH02R



1 / 20 / 80

5+3W



5W XTE	3W LED	280Lm 100Lm	6500K	IPX4
Li-Ion	1200mAh	5W-3,5h	2,5h	
5V/1A	30cm	IR SENSOR	POWER INDICATOR	UV free
MODE		XTE30%/XTE100%/LED/OFF LED/LED/OFF		
		Hg free		



art.nr.: LH03R



1 / 20 / 80

5W

5W CREE	RED LED	260 Lm	6500K	IPX3
Li-ion	1800mAh	5W-4h	3.5h	POWER INDICATOR
5V/1A	50cm	Hg free	UV free	

MODE
100% CREE / 30% CREE / * CREE / LED / * LED / OFF



1 / 20 / 80



art.nr.
LH04R

5+3W

5W CREE	3W COB	320+ 170Lm	6000K	IPX4
Li-ion	1800mAh	5W-3h	3.5h	POWER INDICATOR
5V/1A	50cm	Hg free	UV free	

MODE
100% CREE / 30% CREE / * CREE / LED / * LED / OFF

3s COB/OFF

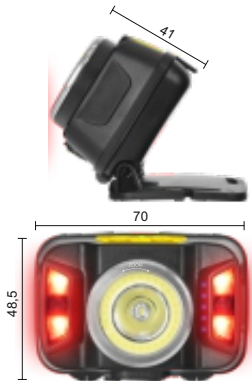

1 / 20 / 80



art.nr.
LH05R

5+3W



1 / 20 / 80



art.nr.: LH06R

5W SMD	3W COB	210 Lm	IP42	
Li-ion	800mAh	SMD-2h	COB-4h	
5V/1A	50cm		UV free	Hg free

MODE	100%COB/40%COB/•COB/••COB/OFF
	100%SMD/45%SMD/•SMD/OFF



3+3W

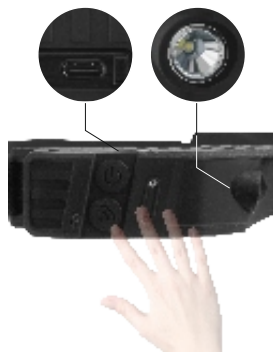

1 / 20 / 80



art.nr.: LH07R

3W SMD	5W COB	500Lm 70Lm	IP44	
Li-ion	2000mAh	SMD-7h	COB-1.5h	
IR SENSOR	5V/1A	30cm	UV free	Hg free

MODE	100%COB/30%COB/100%•COB/30%•COB
	100%SMD/45%SMD/OFF



50Lm	6000K	IP20	0% 100%	
	3000mAh	1W-32h		POWER BANK
POWER INDICATOR	30cm	UV free	Hg free	

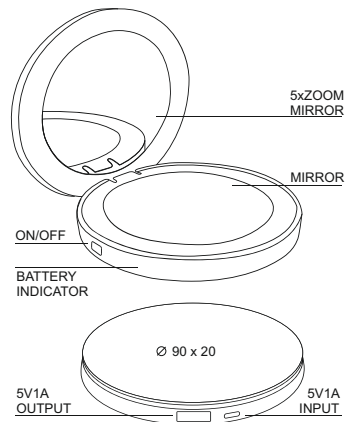

CANDY
art.nr.:
ML01R

250 Lm	6000K	IP44	0% 100%	
	1,5V	6-8h	UV free	Hg free

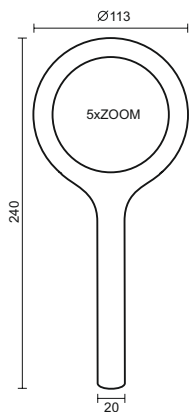

art.nr.:
LM102

40W

LIFUD[®]
LED Driver **SLIM**
BACKLITE

40W

LIFUD[®]
LED Driver **SLIM**
BACKLITE **UGR_a≥9**



art.nr.:
PL5024



art.nr.:
PL5024U



PROFI PLUS	4000 Lm	4000K	AC 220-240V	50/60 Hz
IP20		CRI=80		
			UV free	Hg free
	<1.0sec			

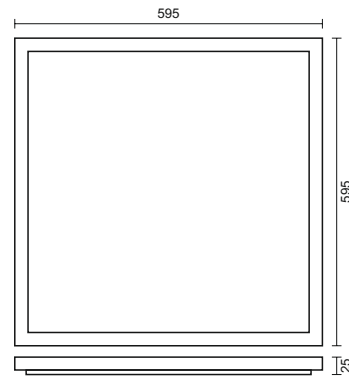

40W

LIFUD[®]
LED Driver **SLIM**
BACKLITE

40W

LIFUD[®]
LED Driver **SLIM**
BACKLITE **UGR_a≥9**



E
art.nr.:
PL5224



E
art.nr.:
PL5224U



PROFI PLUS	4800 Lm	4000K	AC 220-240V	50/60 Hz
IP20		CRI=80		
			UV free	Hg free
	<1.0sec			

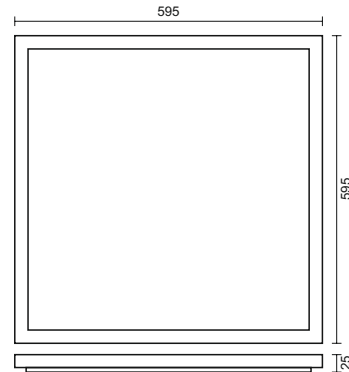

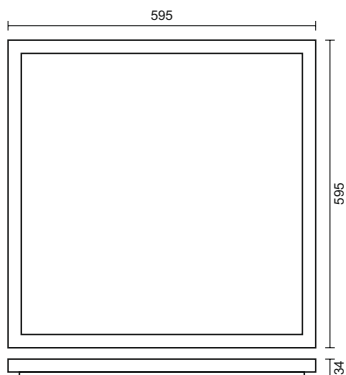
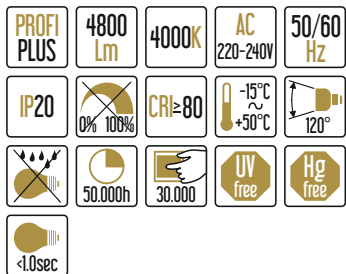

UGR \geq 19 **PHILIPS**
LED Driver



D
art.nr.:
PL5523U

32W

PHILIPS
LED Driver



D
art.nr.:
PL5523

32W

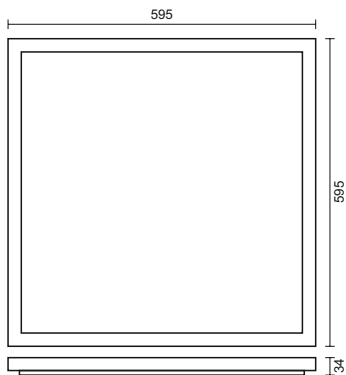
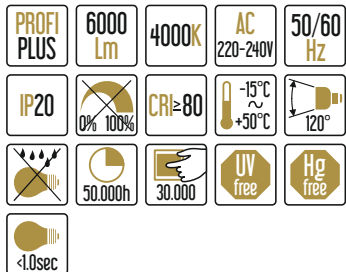

UGR \geq 19 **PHILIPS**
LED Driver



D
art.nr.:
PL5524U

40W

PHILIPS
LED Driver



D
art.nr.:
PL5524

40W

45W

LIFUD
LED Driver

UGR≥ 19



PROFI PLUS	6750 Lm	4000K	AC 220-240V	50/60 Hz
IP20	0% 100%	CRI=80	-15°C ~ +50°C	120°
	50.000h	30.000	UV free	Hg free
	<math>< 1.0\text{sec}</math>			

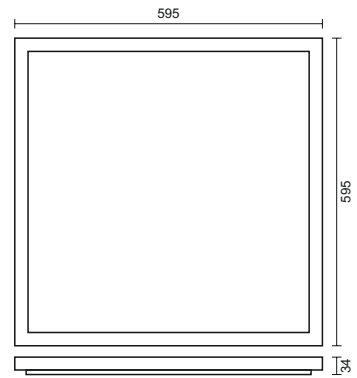

D

art.nr.:
PL5525U

1/5

30W

PHILIPS
LED Driver



PROFI PLUS	5100 Lm	4000K	AC 220-240V	50/60 Hz
IP20	0% 100%	CRI=80	-15°C ~ +50°C	120°
	50.000h	30.000	UV free	Hg free
	<math>< 1.0\text{sec}</math>			

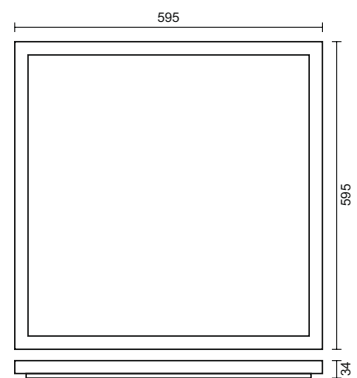

C

art.nr.:
PL5722

1/5

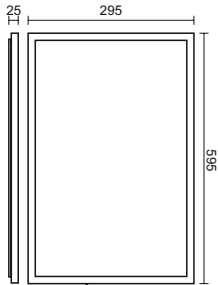
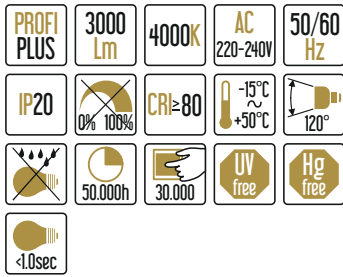

E
art.nr.:
PL6221U

25W



E
art.nr.:
PL6221

25W

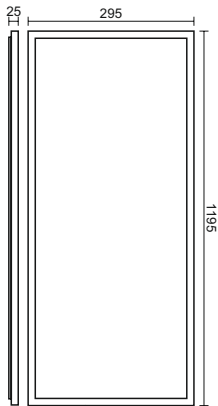
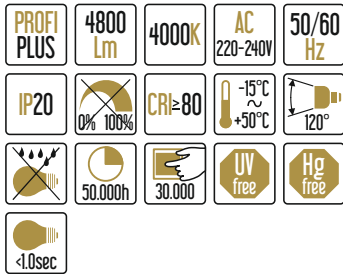

E
art.nr.:
PL7224U

40W



E
art.nr.:
PL7224

40W

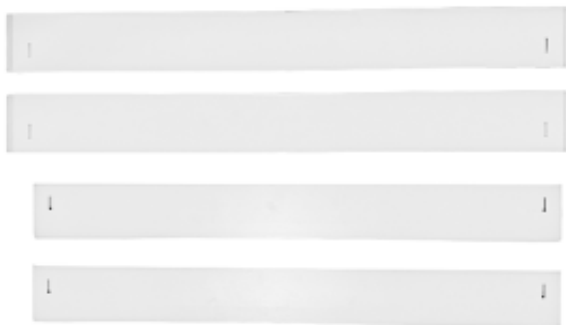

art.nr.:
MS521

USED FOR
PL 5.

1 / 25

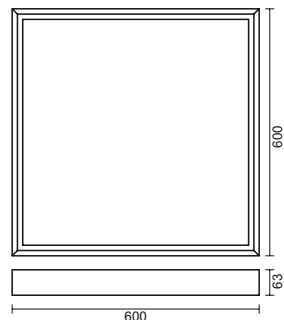

art.nr.:
MS621

USED FOR
PL 6.

1 / 25

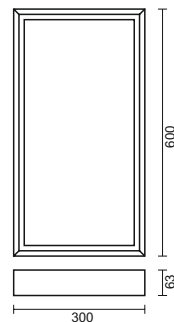

art.nr.:
MS721

USED FOR:
PL 7.

1 / 25

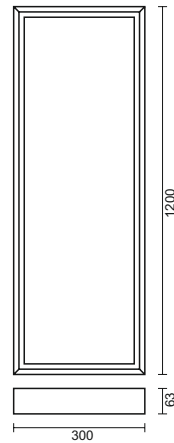

40W

3400 Lm	4500K	AC 180-240V	50Hz	120°
IP20	0% 100%	CRI=80	-15°C +50°C	<1.0sec
40.000h	25.000	UV free	Hg free	

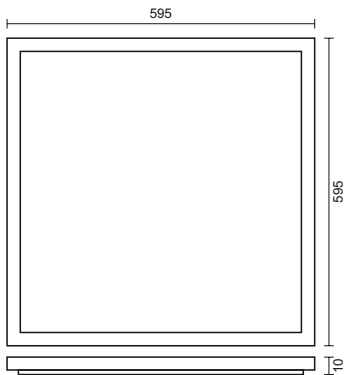

1 / 10



art.nr.:
PL121

40W

4050 Lm	4500K	AC 180-240V	50Hz	120°
IP20	0% 100%	CRI=80	-15°C +50°C	<1.0sec
40.000h	25.000	UV free	Hg free	

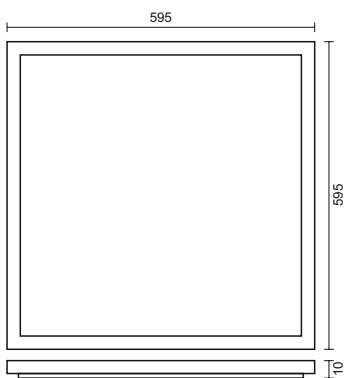

EXCLUSIVE



1 / 10



art.nr.:
PL121H

40W



UGR ≥ 19

4050 Lm	4000K	AC 180-240V	50Hz	120°
IP20	0% 100%	CRI ≥ 80	-15°C ~ +50°C	<1.0sec
40.000h	25.000	UV free	Hg free	

art.nr.: PL121H/U

1 / 10

8 585040 903103

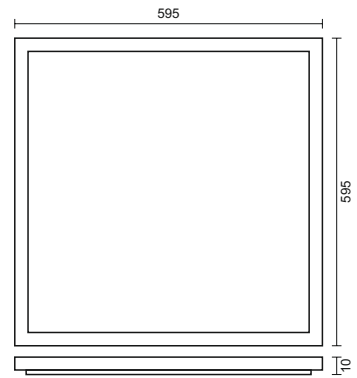

32W



PROFI PLUS UGR ≥ 19

4050 Lm	4000K	AC 180-240V	50Hz	120°
IP20	0% 100%	CRI ≥ 80	-15°C ~ +50°C	<1.0sec
40.000h	25.000	UV free	Hg free	

art.nr.: PL120P/U

1 / 10

8 585040 902690

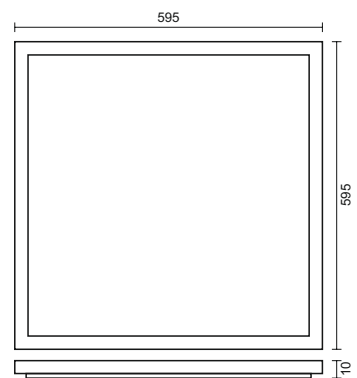

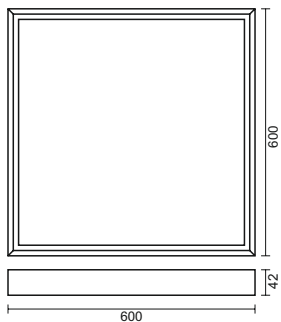

USED FOR:
PL I.

1 / 20



art.nr.:
MS121N

HANGING

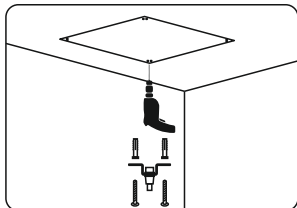
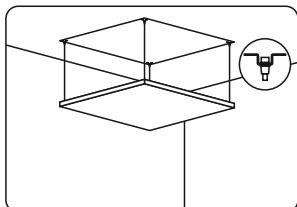

USED FOR:
PL 121, PL 121H
PL 121H/U
PL 120P/U

1 / 50



art.nr.:
SN100

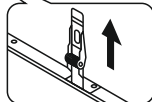
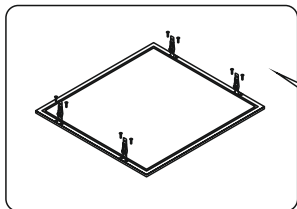
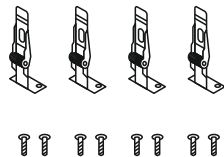
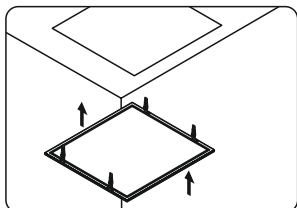

USED FOR:
PL 121, PL 121H
PL 121H/U
PL 120P/U

1 / 100



CLIPS

art.nr.:
SNR001

6W



410 Lm
2800K

1/60



art.nr.: LPL111

6W



420 Lm
4000K

1/60



art.nr.: LPL121

AC 85-265V	50/60 Hz	CRI≥80	0% 100%	120°
IP20	~ -5°C +40°C	30.000h	30.000	
UV free	Hg free	<1.0sec	0.5m	0.2m

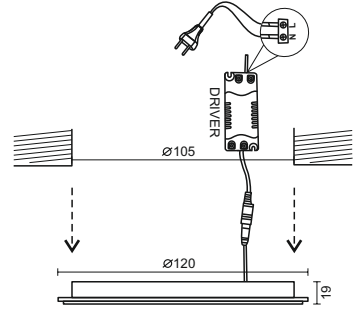

12W



950 Lm
2800K

1/40



art.nr.: LPL113

12W



960 Lm
4000K

1/40



art.nr.: LPL123

AC 85-265V	50/60 Hz	CRI≥80	0% 100%	120°
IP20	~ -5°C +40°C	30.000h	30.000	
UV free	Hg free	<1.0sec	0.5m	0.2m

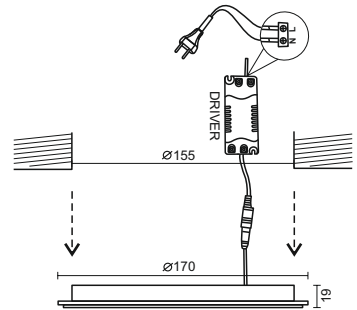

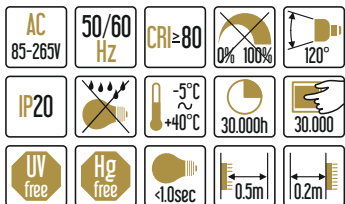

1520
Lm

4000K



art.nr.:
LPL124

18W

1510
Lm

2800K



art.nr.:
LPL114

18W

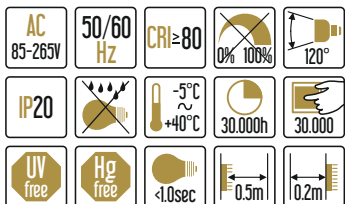

2000
Lm

4000K



art.nr.:
LPL125

24W

2000
Lm

2800K



art.nr.:
LPL115

24W

6W



410 Lm
2800K

1/60

art.nr.: LPL211



6W



420 Lm
4000K

1/60

art.nr.: LPL221



AC 85-265V	50/60 Hz	CRI≥80	0% 100%	120°
IP20	~-5°C ~+40°C	30.000h	30.000	
UV free	Hg free	<1.0sec	0.5m	0.2m

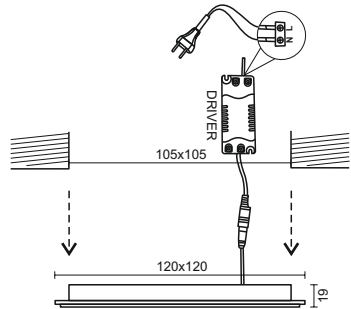

12W



950 Lm
2800K

1/40

art.nr.: LPL213



12W



960 Lm
4000K

1/40

art.nr.: LPL223



AC 85-265V	50/60 Hz	CRI≥80	0% 100%	120°
IP20	~-5°C ~+40°C	30.000h	30.000	
UV free	Hg free	<1.0sec	0.5m	0.2m

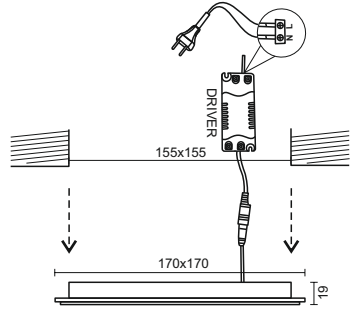

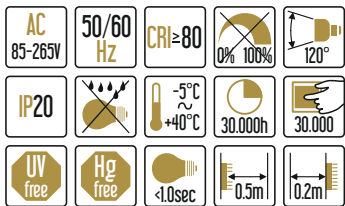

1520
Lm

4000K



art.nr.:
LPL224

18W

1510
Lm

2800K



art.nr.:
LPL214

18W

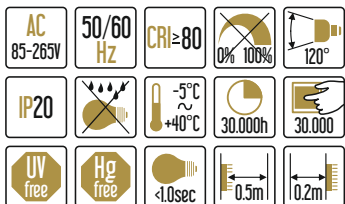

2000
Lm

4000K



art.nr.:
LPL225

24W

2000
Lm

2800K



art.nr.:
LPL215

24W

6W



420
Lm
4000K

AC 85-265V	50/60 Hz	CRI=80	0% 100%	120°
IP20		-5°C ~ +40°C	30.000h	30.000
UV free	Hg free	<1.0sec	0.5m	

art.nr.:
LPL321

1 / 20

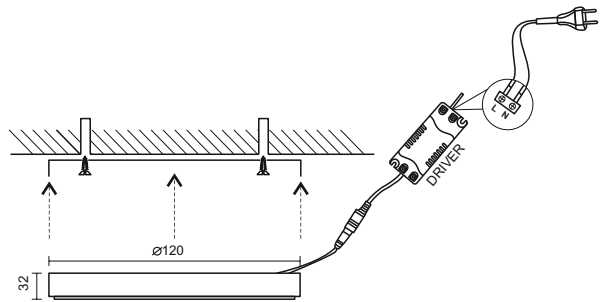

12W



960
Lm
4000K

AC 85-265V	50/60 Hz	CRI=80	0% 100%	120°
IP20		-5°C ~ +40°C	30.000h	30.000
UV free	Hg free	<1.0sec	0.5m	

art.nr.:
LPL323

1 / 20

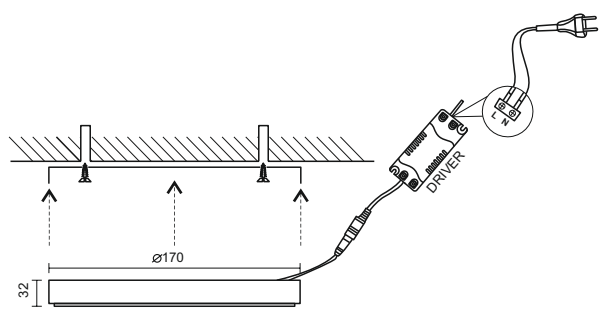

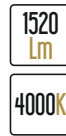
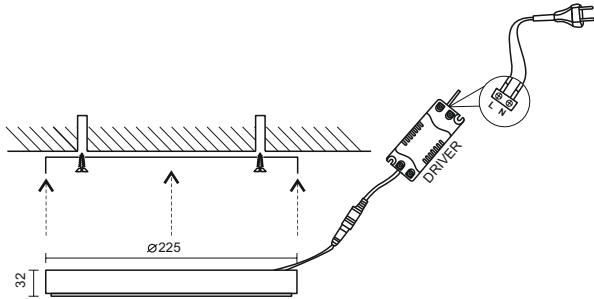
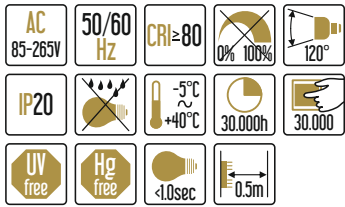

18W

1 / 20



art.nr.:
LPL324

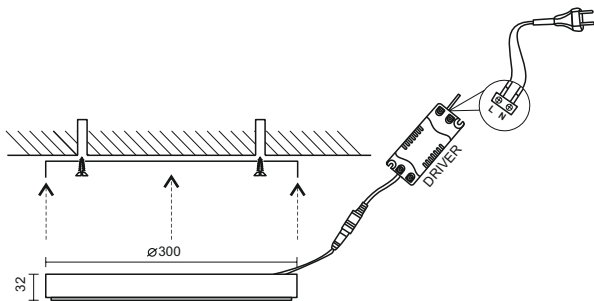
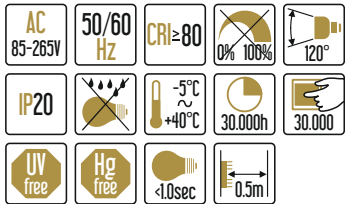

24W

1 / 20



art.nr.:
LPL325

6W



420
Lm
4000K

AC 85-265V	50/60 Hz	CRI=80	0% 100%	120°
IP20	UV free	-5°C +40°C	30.000h	30.000
UV free	Hg free	<1.0sec	0.5m	

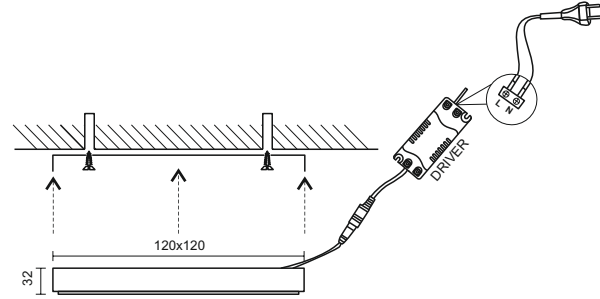

art.nr.:
LPL421



12W



960
Lm
4000K

AC 85-265V	50/60 Hz	CRI=80	0% 100%	120°
IP20	UV free	-5°C +40°C	30.000h	30.000
UV free	Hg free	<1.0sec	0.5m	

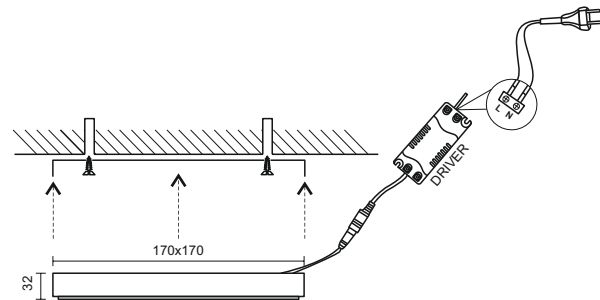

art.nr.:
LPL423



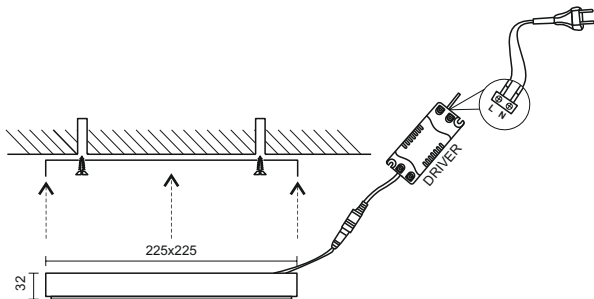
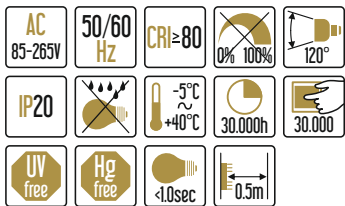

1520
Lm

4000K



18W

1 / 20



art.nr.
LPL424

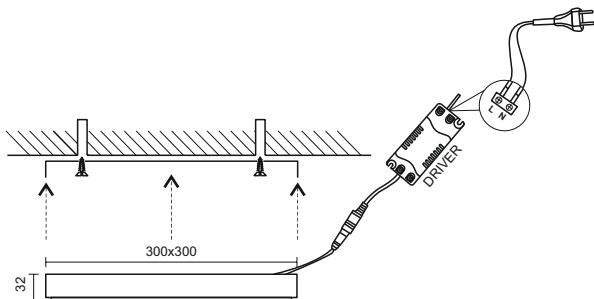
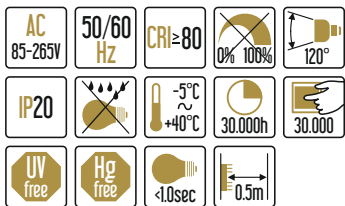

2000
Lm

4000K



24W

1 / 20



art.nr.
LPL425

0.4W



7Lm
2800K

0.4W



7Lm
4000K

art.nr.:
LFL110



art.nr.:
LFL120



100KG	DC12V	50Hz	0% 100%	120°
IP67	CRI≥80	-30°C ~ +65°C	30.000h	50.000
UV free	Hg free	<1.0sec	CABLE	0.5m

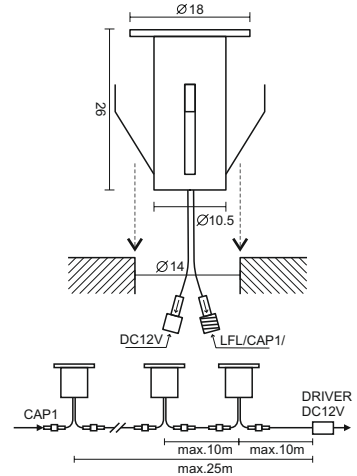

0.6W

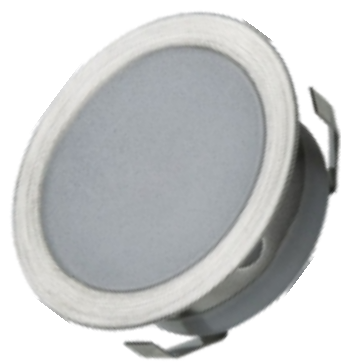

6Lm
2800K

0.6W



6Lm
4000K

art.nr.:
LFL111



art.nr.:
LFL121



100KG	DC12V	50Hz	0% 100%	120°
IP67	CRI≥80	-30°C ~ +65°C	30.000h	50.000
UV free	Hg free	<1.0sec	CABLE	0.5m

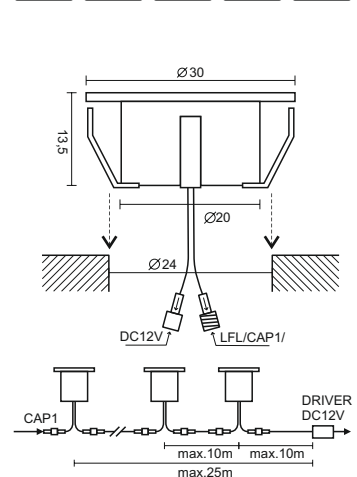

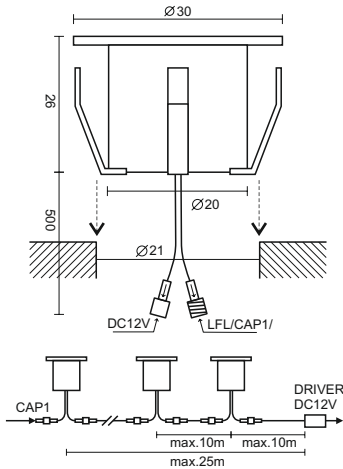
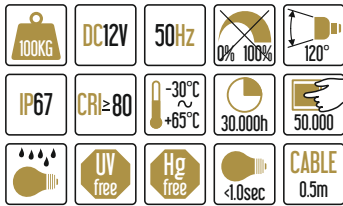

40Lm
4000K



art.nr.:
LFL122

0.6W

40Lm
2800K



art.nr.:
LFL122

0.6W

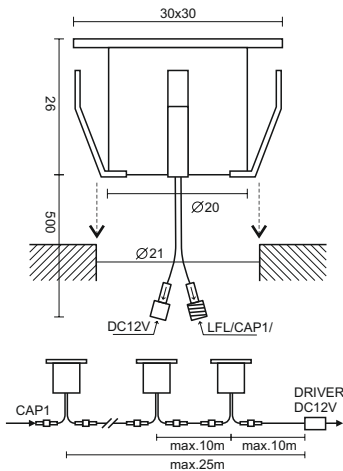
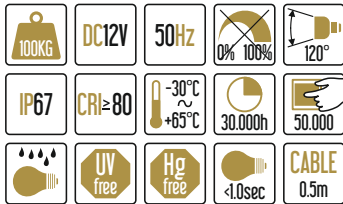

40Lm
4000K



art.nr.:
LFL122S

0.6W

40Lm
2800K



art.nr.:
LFL122S

0.6W

0.4W

0.4W

60Lm
2800K

60Lm
4000K

- 100KG
- DC12V
- 50Hz
- 0% 100%
- 120°
- IP67
- CRI ≥ 80
- 30°C ~ +65°C
- 30.000h
- 50.000
- UV free
- Hg free
- <1.0sec
- CABLE 1m

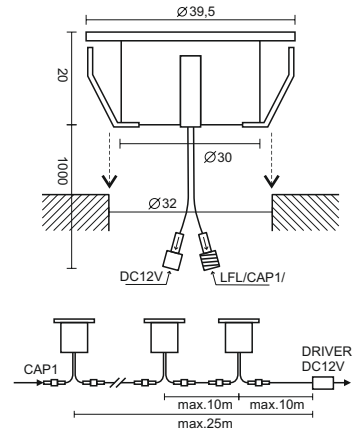

art.nr.: LFL113



art.nr.: LFL123



1.5W

1.5W

110Lm
(360°)
2800K

110Lm
(360°)
4000K

- 100KG
- DC12V
- 50Hz
- 0% 100%
- 120°
- IP67
- CRI ≥ 80
- 30°C ~ +65°C
- 30.000h
- 50.000
- UV free
- Hg free
- <1.0sec
- CABLE 0.5m

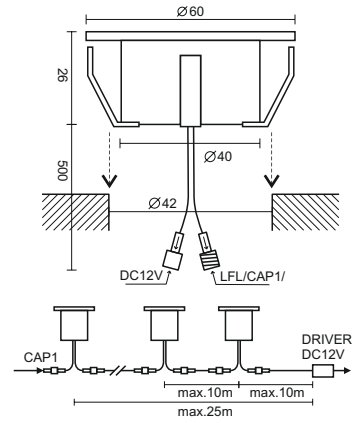

art.nr.: LFL114



art.nr.: LFL124





LED
POWER
SUPPLY

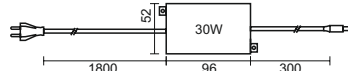
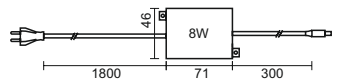

MAX
30W

USED FOR :
LFL110/LFL120-max.65pcs
LFL111/LFL121-max.45pcs
LFL112/LFL122-max.45pcs
LFL112S/LFL122S-max.45pcs
LFL113/LFL123-max.65pcs
LFL114/LFL124-max.18pcs

1 / 5 / 50



art.nr.:
PSF104

MAX
60W LIGHT
SENSOR

USED FOR :
LFL110/LFL120-max.130pcs
LFL111/LFL121-max.90pcs
LFL112/LFL122-max.90pcs
LFL112S/LFL122S-max.90pcs
LFL113/LFL123-max.130pcs
LFL114/LFL124-max.36pcs

1 / 5 / 50



art.nr.:
LSF101

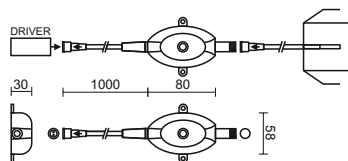

3m

1 / 100



art.nr.:
WLF103

2m

1 / 100



art.nr.:
WLF102

1m

1 / 100



art.nr.:
WLF101

30W

8W

MAX
8W

USED FOR:
LFL110/LFL120-max.18pcs
LFL111/LFL121-max.12pcs
LFL112/LFL122-max.12pcs
LFL112S/LFL122S-max.12pcs
LFL113/LFL123-max.18pcs
LFL114/LFL124-max.5pcs

1 / 5 / 50



art.nr.:
PSF103

60W

IP67

END CAP



1 / 500



art.nr.:
CAP1



EXTENSION

EXTENSION

EXTENSION



4W



210Lm
(Φuse)

210Lm
(90°)

2800K

4W



220Lm
(Φuse)

220Lm
(90°)

4000K



art.nr.:
LGL514

1/5/30



art.nr.:
LGL524

1/5/30

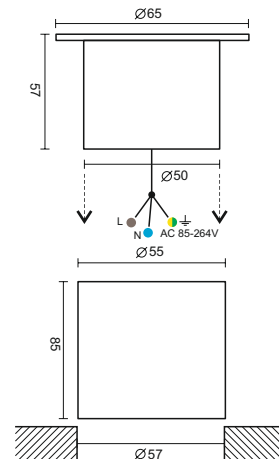
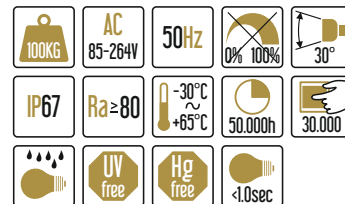

4W



210Lm
(Φuse)

210Lm
(90°)

2800K

4W



220Lm
(Φuse)

220Lm
(90°)

4000K



art.nr.:
LGL514S

1/5/30



art.nr.:
LGL524S

1/5/30

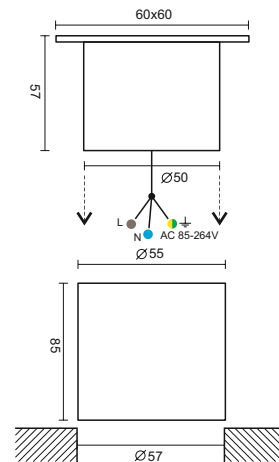
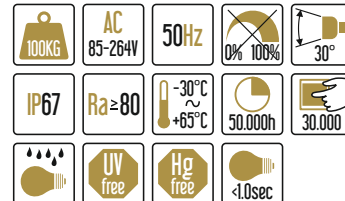

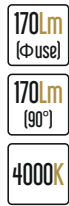
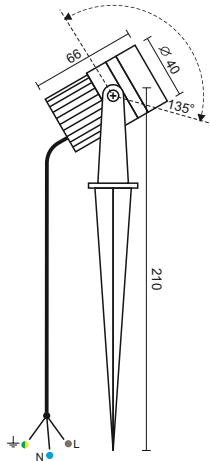
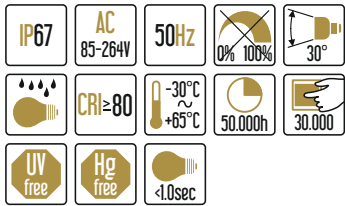

3W

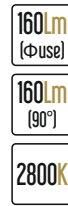

3W

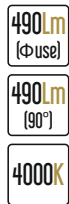
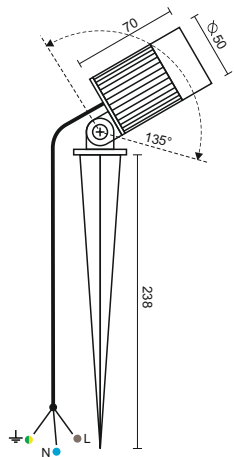
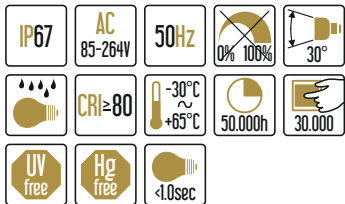

7W

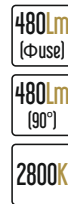

7W





70Lm
(TOTAL)

200Lm
(360°)

2800K

3W



art.nr.:
LGL211

1/3/12



art.nr.:
LGL221

1/3/12



70Lm
(TOTAL)

200Lm
(360°)

4000K

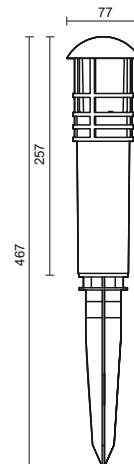
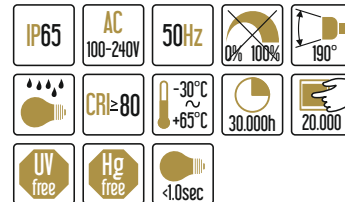

150Lm
(TOTAL)

200Lm
(360°)

2800K

3W



art.nr.:
LGL311

1/6/24



art.nr.:
LGL321

1/6/24



150Lm
(TOTAL)

200Lm
(360°)

4000K

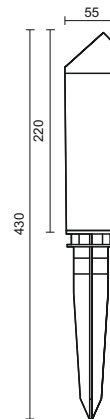
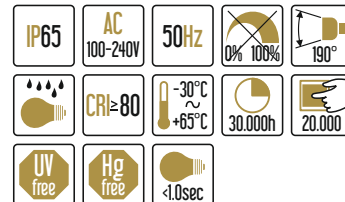

AC/DC
250V

IP67

MAX
3x1.5m

MAX
∅10mm

MAX
↓1.0m

-40°C
~
+105°C

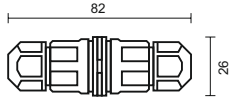

1 / 20 / 500



art.nr.
CW132

AC/DC
250V

IP67

MAX
3x1.5m

MAX
∅10mm

MAX
↓1.0m

-40°C
~
+105°C

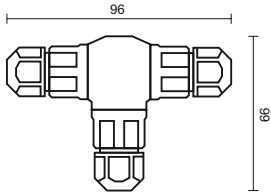

1 / 10 / 200



art.nr.
CW133

AC/DC
250V

IP67

MAX
3x1.5m

MAX
∅10mm

MAX
↓1.0m

-40°C
~
+105°C

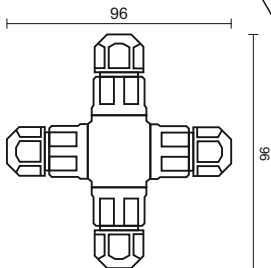
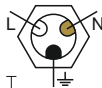

1 / 5 / 200



art.nr.
CW134

12W



art.nr.: LS022

SOLAR	PIR SENSOR	3 MODES
-------	------------	---------



1 / 10

1200 Lm	3000K 4100K 6500K	CRI=80	0% 100%	120°
IP54		5.5V	600mA	-15°C +45°C
Li-ion	4400mA	20h 5% CCT	1h 100% CCT	CABLE 3m
8-9h (50.000Lx)	UV free	Hg free	0.5m	

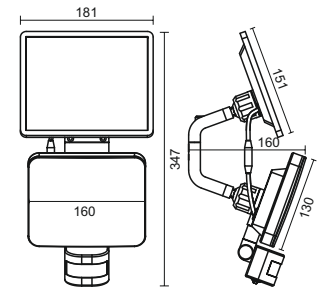

PIR SENSOR / 160°
LUX: 10 - 10000LUX (☆)
SENS: 1m - 10m
TIME: 10sec - 60sec

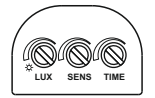

12W



art.nr.: LS023

SOLAR	PIR SENSOR	3 MODES	5V/1A
-------	------------	---------	-------



1 / 8

1200 Lm	3000K 4100K 6500K	CRI=80	0% 100%	120°
IP54		5.5V	600mA	-15°C +45°C
Li-ion	4400mA	20h 5% CCT	1h 100% CCT	CABLE 3m
8-9h (50.000Lx)	UV free	Hg free	0.5m	

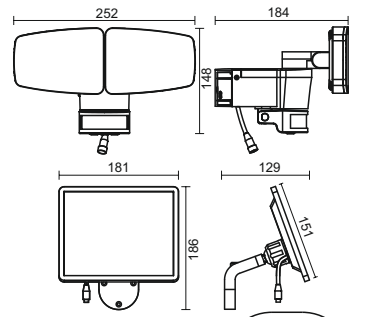

PIR SENSOR / 160°
LUX: 10 - 10000LUX (☆☆)
SENS: 1m - 10m
TIME: 10sec - 60sec

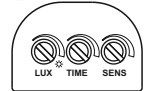

5W

500 Lm	4000K	CRI=80	0% 100%	120°
IP54		5.5V	300mA	-15°C +45°C
Li-ion	1500mA	20h	1h	0.5m
5-6h (50.000Lx)	UV free	Hg free		

4 MODES	PIR SENSOR	SOLAR
---------	------------	-------

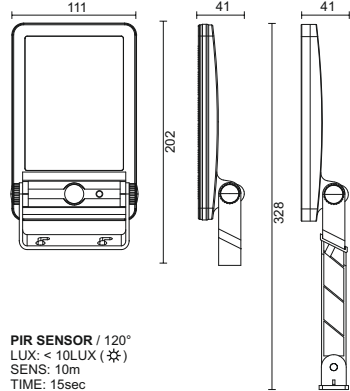

1 / 30

art.nr.: LS024

300Lm (4000K)	15Lm (3000K)	3000K 4000K	CRI>80	0% 100%
IP54		5.5V	100mA	120°
Li-ion	1200mA	20h	1h	-15°C +45°C
12-15h (50.000Lx)	UV free	Hg free		0.5m

3 MODES	PIR SENSOR	SOLAR
---------	------------	-------

3W



3 MODES	PIR SENSOR	SOLAR
---------	------------	-------

3W



3 MODES	PIR SENSOR	SOLAR
---------	------------	-------

3W

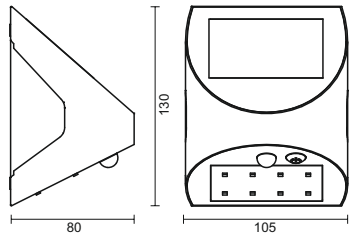

1 / 40

art.nr.: LS225

1 / 40

art.nr.: LS125

1 / 40

art.nr.: LS025

PIR SENSOR / 120°
LUX: < 10LUX (✖)
SENS: 5m
TIME: 30sec

www.nedes.eu

24W



art.nr.:
LFX021



1/6

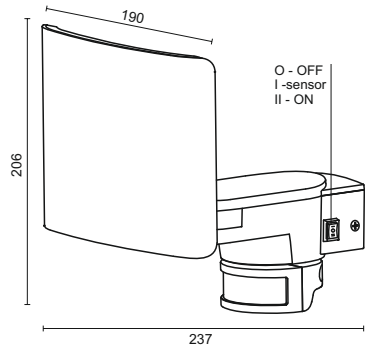

1900 Lm	4000K	AC 220-240V	0% 100%	120°
IP54	CRI≥80	<1.0sec	-15°C +45°C	
UV free	Hg free	25.000h	20.000	50/60 Hz
0.5m				

PIR SENSOR / 120°
LUX: 5 - 2000LUX (✳)
SENS: 2m - 12m
TIME: Min. 5sec - 1min
220-240V / AC 50Hz

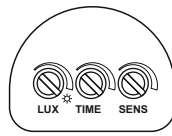

24W



art.nr.:
LFX121



1/6

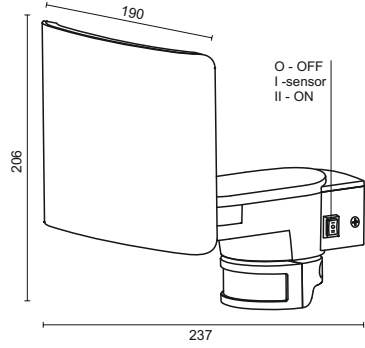

1900 Lm	4000K	AC 220-240V	0% 100%	120°
IP54	CRI≥80	<1.0sec	-15°C +45°C	
UV free	Hg free	25.000h	20.000	50/60 Hz
0.5m				

PIR SENSOR / 120°
LUX: 5 - 2000LUX (✳)
SENS: 2m - 12m
TIME: Min. 5sec - 1min
220-240V / AC 50Hz

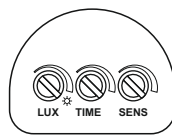

24W



art.nr.:
LFX221



1/6

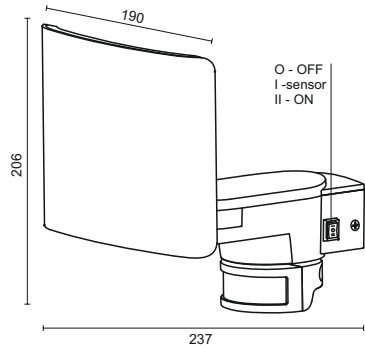

1900 Lm	4000K	AC 220-240V	0% 100%	120°
IP54	CRI≥80	<1.0sec	-15°C +45°C	
UV free	Hg free	25.000h	20.000	50/60 Hz
0.5m				

PIR SENSOR / 120°
LUX: 5 - 2000LUX (✳)
SENS: 2m - 12m
TIME: Min. 5sec - 1min
220-240V / AC 50Hz

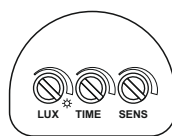

24W

1900 Lm	3000K 4000K 6000K	AC 220-240V	0% 100%	120°
IP54	CRI=80	<1.0sec	-15°C +45°C	
UV free	Hg free	25.000h	20.000	50/60 Hz
0.5m				

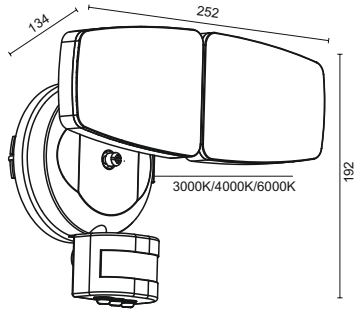

PIR SENSOR / 120°
LUX: 5 - 2000LUX (✱)
SENS: 2m - 12m
TIME: Min. 5sec - 1min
220-240V / AC 50Hz

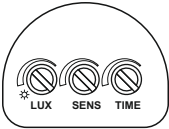

1/4



art.nr.
LFX025

1900 Lm	3000K 4000K 6000K	AC 220-240V	0% 100%	120°
IP54	CRI=80	<1.0sec	-15°C +45°C	
UV free	Hg free	25.000h	20.000	50/60 Hz
0.5m				

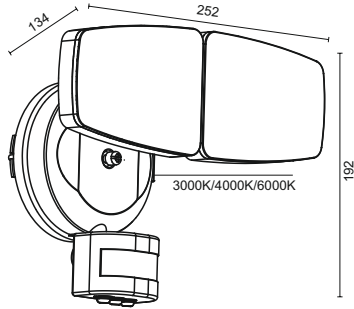

PIR SENSOR / 120°
LUX: 5 - 2000LUX (✱)
SENS: 2m - 12m
TIME: Min. 5sec - 1min
220-240V / AC 50Hz

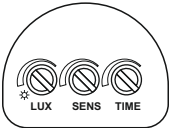

1/4



art.nr.
LFX125

24W

1900 Lm	3000K 4000K 6000K	AC 220-240V	0% 100%	120°
IP54	CRI=80	<1.0sec	-15°C +45°C	
UV free	Hg free	25.000h	20.000	50/60 Hz
0.5m				

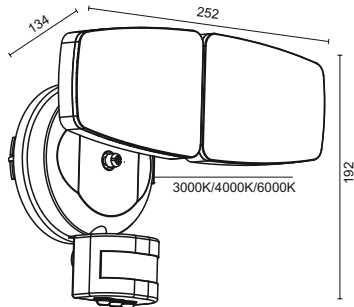

PIR SENSOR / 120°
LUX: 5 - 2000LUX (✱)
SENS: 2m - 12m
TIME: Min. 5sec - 1min
220-240V / AC 50Hz

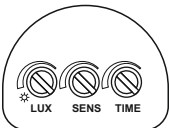

1/4



art.nr.
LFX225

24W

10W

800 Lm



art.nr.: LF0021



20W

1600 Lm



art.nr.: LF0022



4000K	AC 220-240V	120°	CRI ≥ 80	0% 100%
IP65	50/60 Hz	25.000h	20.000	
UV free	Hg free	<1.0sec	-15°C ~ +45°C	0.5m

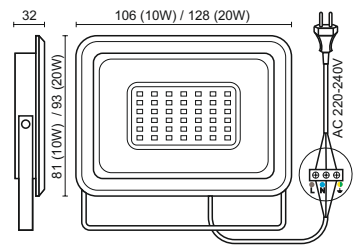

30W

2400 Lm



art.nr.: LF0023



50W

4000 Lm



art.nr.: LF0024



4000K	AC 220-240V	120°	CRI ≥ 80	0% 100%
IP65	50/60 Hz	25.000h	20.000	
UV free	Hg free	<1.0sec	-15°C ~ +45°C	0.5m

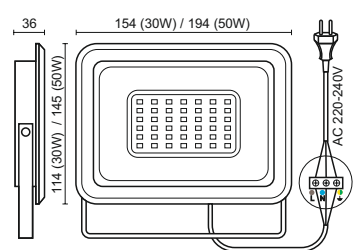

100W

8000 Lm	4000K	AC 220-240V	CRI ≥ 80	50/60 Hz
IP65		SMD	25.000h	20.000
120°	0% 100%		-15°C ~ +45°C	0.5m
UV free	Hg free			

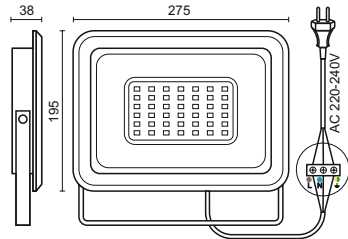

1 / 10

8 585040 916754

art.nr.: LF0025

1600 Lm	4000K	AC 220-240V	CRI ≥ 80	50/60 Hz
120°		SMD	25.000h	20.000
0% 100%		-15°C ~ +45°C	UV free	Hg free
0.5m				

IP44

PIR SENSOR

20W

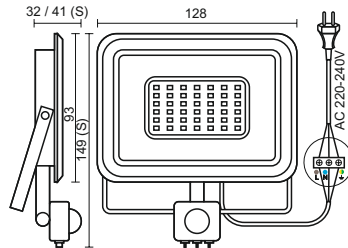

1 / 40

8 585040 916778

art.nr.: LF0122S

IP65

20W



PIR SENSOR / 120°
 0.6m/s - 1.5m/s
 LUX: 10 - 2000LUX (☼)
 SENS: 2m - 8m
 TIME: Min. 5sec ± 2sec
 Max. 8min ± 3min
 220-240V / AC 50Hz

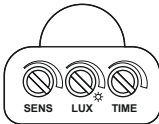

1 / 60

8 585040 916761

art.nr.: LF0122

10W

800
Lm



art.nr.:
LF0021S



1 / 50

20W

1600
Lm



art.nr.:
LF0022S



1 / 40

4000K	AC 220-240V	0% 100%	120°	-15°C ~ +45°C
IP44	☀️	CRI=80	<1.0sec	50/60 Hz
UV free	Hg free	25.000h	20.000	0.5m

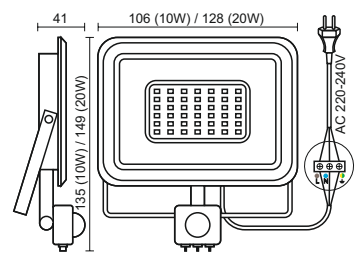

PIR SENSOR / 120°
0.6m/s - 1.5m/s
LUX: 10 - 2000LUX (☼)
SENS: 2m - 8m
TIME: Min. 5sec ± 2sec
Max. 8min ± 3min
220-240V / AC 50Hz

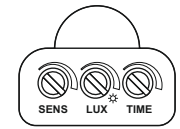

30W

2400
Lm



art.nr.:
LF0023S



1 / 30

50W

4000
Lm



art.nr.:
LF0024S



1 / 20

4000K	AC 220-240V	0% 100%	120°	-15°C ~ +45°C
IP44	☀️	CRI=80	<1.0sec	50/60 Hz
UV free	Hg free	25.000h	20.000	0.3m

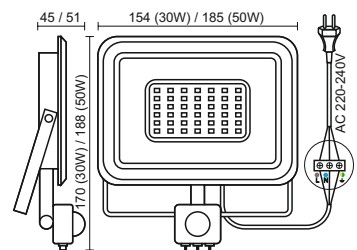

PIR SENSOR / 120°
0.6m/s - 1.5m/s
LUX: 10 - 2000LUX (☼)
SENS: 2m - 8m
TIME: Min. 5sec ± 2sec
Max. 8min ± 3min
220-240V / AC 50Hz

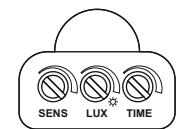

20W

1800 Lm	4000K	AC 200-265V	120°	0% 100%
IP44	50/60 Hz	30.000h	25.000	
IK08	CRI ≥ 80	<1.0sec	-25°C ~ +45°C	0.5m
UV free	Hg free			

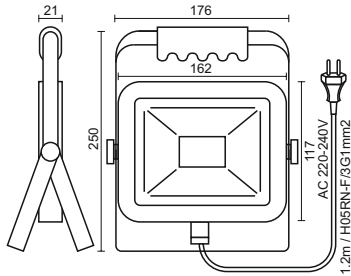

art.nr.: LF2022H

30W

2700 Lm	4000K	AC 200-265V	120°	0% 100%
IP44	50/60 Hz	30.000h	25.000	
IK08	CRI ≥ 80	<1.0sec	-25°C ~ +45°C	0.5m
UV free	Hg free			

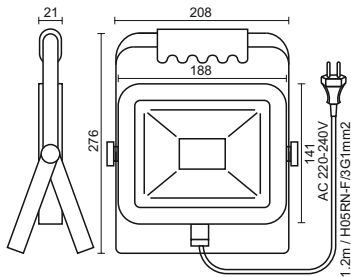

art.nr.: LF2023H

500W



4500 Lm	4000K	AC 200-265V	120°	0% 100%
IP44		50/60 Hz	30.000h	25.000
IK08	CRI ≥ 80	 <1.0sec	-25°C ~ +45°C	0.5m
UV free	Hg free			

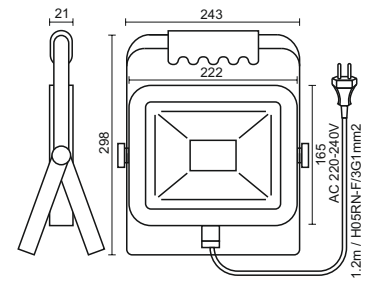

art.nr.:
LF2024H

1 / 10

8 585040 903617

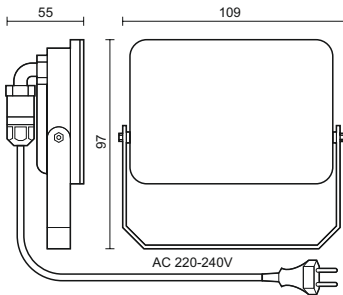
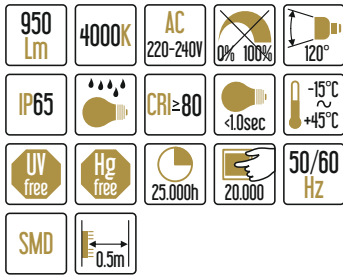

art.nr.:
LF7121

10W



art.nr.:
LF7021

10W

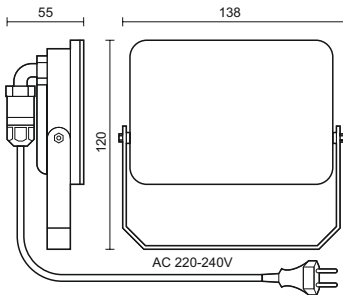
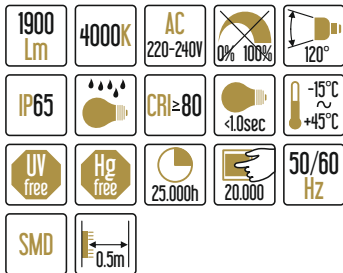

art.nr.:
LF7122

20W



art.nr.:
LF7022

20W

30W



art.nr.: LF7023



30W



art.nr.: LF7123



2850 Lm	4000K	AC 220-240V	0% 100%	120°
IP65	CRI=80	<1.0sec	-15°C ~ +45°C	
UV free	Hg free	25.000h	20.000	50/60 Hz
SMD	0.5m			

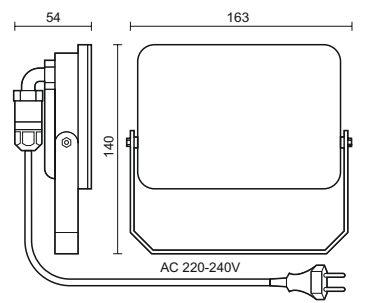

50W



art.nr.: LF7024



50W



art.nr.: LF7124



4750 Lm	4000K	AC 220-240V	0% 100%	120°
IP65	CRI=80	<1.0sec	-15°C ~ +45°C	
UV free	Hg free	25.000h	20.000	50/60 Hz
SMD	0.5m			

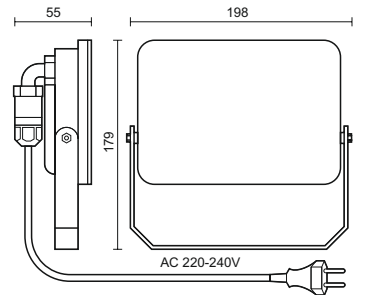

9500 Lm	4000K	AC 220-240V	0% 100%	120°
IP65		CRI=80	<1.0sec	-15°C +45°C
UV free	Hg free	25.000h	20.000	50/60 Hz
SMD	0.5m			

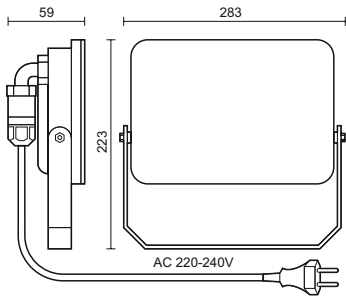

1 / 10



8 585040 916891

10W



art.nr.: LF7021S



10W



art.nr.: LF7121S



950 Lm	4000K	AC 220-240V	0% 100%	120°
IP44		CRI=80	<1.0sec	-15°C ~ +45°C
UV free	Hg free	25.000h	20.000	50/60 Hz
SMD	0.5m			

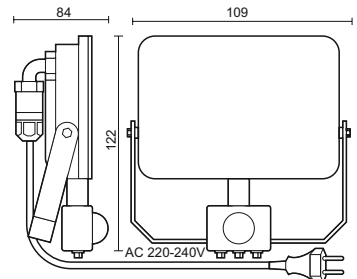

PIR SENSOR / 120°
 0.6m/s - 1.5m/s
 LUX: 10 - 2000LUX (☼)
 SENS: 2m - 8m
 TIME: Min. 5sec ± 2sec
 Max. 8min ± 3min
 220-240V / AC 50Hz

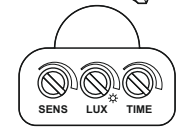

20W



art.nr.: LF7022S



20W



art.nr.: LF7122S



1900 Lm	4000K	AC 220-240V	0% 100%	120°
IP44		CRI=80	<1.0sec	-15°C ~ +45°C
UV free	Hg free	25.000h	20.000	50/60 Hz
SMD	0.5m			

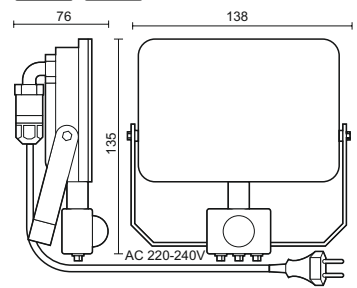

PIR SENSOR / 120°
 0.6m/s - 1.5m/s
 LUX: 10 - 2000LUX (☼)
 SENS: 2m - 8m
 TIME: Min. 5sec ± 2sec
 Max. 8min ± 3min
 220-240V / AC 50Hz

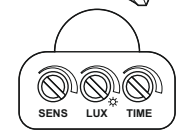

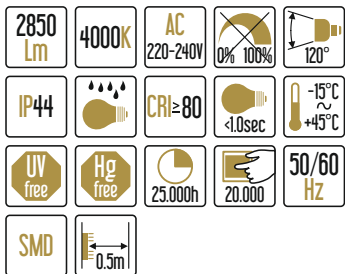

1 / 20



art.nr:
LF7123S



1 / 20



art.nr:
LF7023S

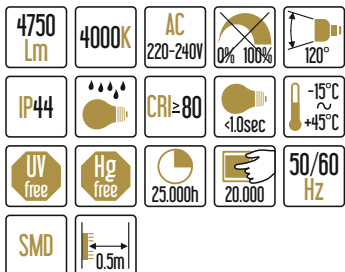

1 / 10



art.nr:
LF7124S



1 / 10



art.nr:
LF7024S

PIR SENSOR / 120°
0.6m/s - 1.5m/s
LUX: 10 - 2000LUX (☼)
SENS: 2m - 8m
TIME: Min. 5sec ± 2sec
Max. 8min ± 3min
220-240V / AC 50Hz

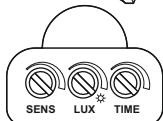

PIR SENSOR / 120°
0.6m/s - 1.5m/s
LUX: 10 - 2000LUX (☼)
SENS: 2m - 8m
TIME: Min. 5sec ± 2sec
Max. 8min ± 3min
220-240V / AC 50Hz

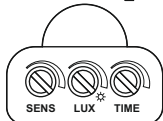

30W



art.nr.: LF6023



1 / 20

PROFI	3300Lm (120°)	3600Lm (TOTAL)	3300Lm (Φuse)	5000K
IP65		AC 180-265V	110°	0% 100%
IK08	CRI ≥ 80	50Hz	30.000h	25.000
UV free	Hg free	<1.0sec	-25°C ~ +45°C	0.5m

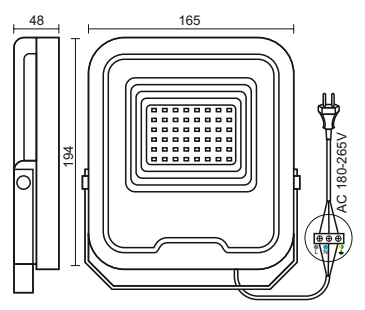

50W



art.nr.: LF6024



1 / 10

PROFI	5100Lm (120°)	6000Lm (TOTAL)	5100Lm (Φuse)	5000K
IP65		AC 180-265V	110°	0% 100%
IK08	CRI ≥ 80	50Hz	30.000h	25.000
UV free	Hg free	<1.0sec	-25°C ~ +45°C	0.5m

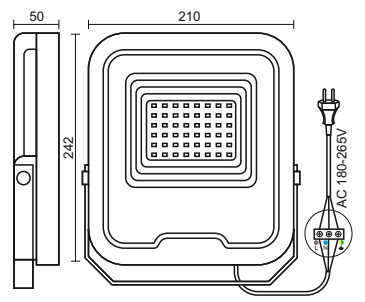

100W

PROFI	9800 Lm (120°)	12000 Lm (TOTAL)	9800 Lm (Φuse)	5000K
IP65		AC 180-265V	 110°	 0% 100%
IK08	CRI ≥ 80	50Hz	 30.000h	 25.000
UV free	Hg free	 <1.0sec	 -25°C ~ +45°C	 0.5m

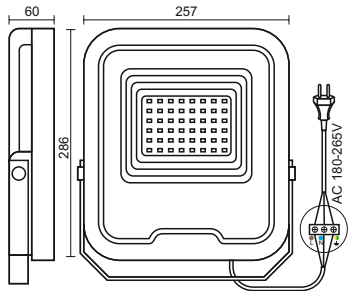

art.nr.:
LF6025

200W

PROFI	20300 Lm (120°)	24000 Lm (TOTAL)	20300 Lm (Φuse)	5000K
IP65		AC 180-265V	 110°	 0% 100%
IK08	CRI ≥ 80	50Hz	 30.000h	 25.000
UV free	Hg free	 <1.0sec	 -25°C ~ +45°C	 0.5m

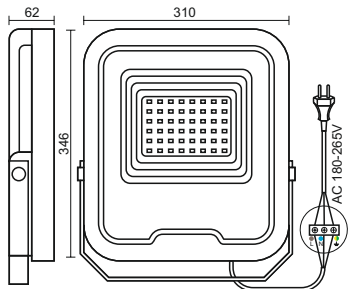

art.nr.:
LF6027

500W

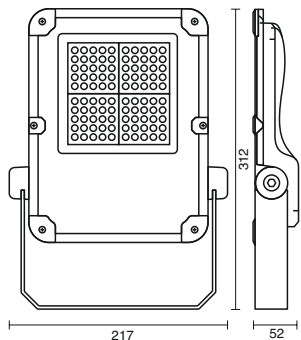

PROFI PLUS	7500 Lm (360°)	5000K	CRI ≥ 80	Pf ≥ 0.9
IP66	☔	AC 120-277V	80x150°	0% 100%
IK06	50/60 Hz	50.000h	30.000	-25°C ~ +50°C
UV free	Hg free	<1.0sec	0.5m	

D

art.nr.: LF4024N

1/10

1000W

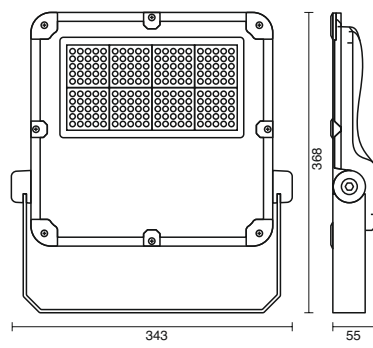

PROFI PLUS	15000 Lm (360°)	5000K	CRI ≥ 80	Pf ≥ 0.9
IP66	☔	AC 120-277V	80x150°	0% 100%
IK06	50/60 Hz	50.000h	30.000	-25°C ~ +50°C
UV free	Hg free	<1.0sec	0.5m	

D

art.nr.: LF4025N

1/4

1500W

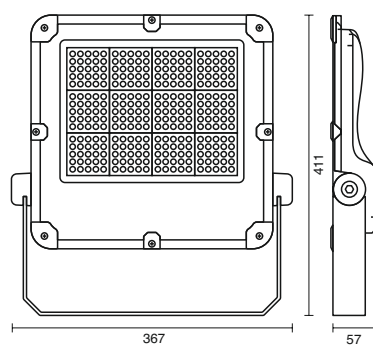

PROFI PLUS	22500 Lm (360°)	5000K	CRI ≥ 80	Pf ≥ 0.9
IP66	☔	AC 120-277V	80x150°	0% 100%
IK06	50/60 Hz	50.000h	30.000	-25°C ~ +50°C
UV free	Hg free	<1.0sec	0.5m	

D

art.nr.: LF4026N

1/4

200W

PROFI PLUS	30000 Lm(360°)	5000K	CRI≥80	Pf≥0.9
IP66		AC 120-277V	80x150°	0% 100%
IK06	50/60 Hz	50.000h	30.000	-25°C +50°C
UV free	Hg free	<1.0sec	0.5m	

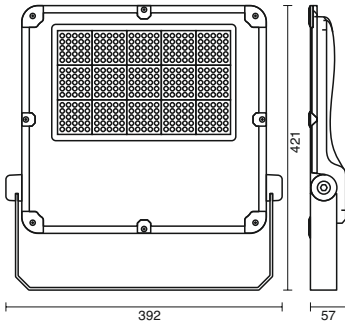

art.nr.:
LF4027N

300W

PROFI PLUS	45000 Lm(360°)	5000K	CRI≥80	Pf≥0.9
IP66		AC 120-277V	80x150°	0% 100%
IK06	50/60 Hz	50.000h	30.000	-25°C +50°C
UV free	Hg free	<1.0sec	0.5m	

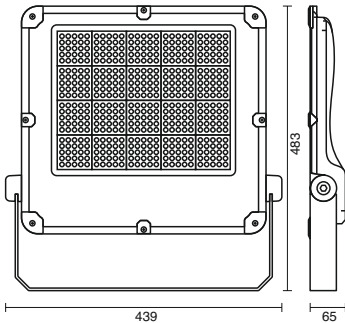

art.nr.:
LF4028N

5W



1060Lm
(360°)

3000K

5W



1060Lm
(360°)

4000K

AC 220-240V	330°	0% 100%	E27	CRI ≥ 80
IP20	-5°C +40°C	30.000h	20.000	
UV free	Hg free	<1.0sec	50Hz	

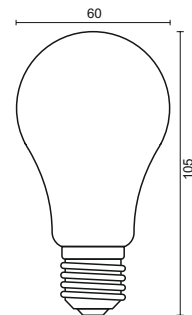

A

art.nr.:
ZLF511A

1 / 10 / 100



A

art.nr.:
ZLF521A

1 / 10 / 100



7.3W



1540Lm
(360°)

3000K

7.3W



1540Lm
(360°)

4000K

AC 220-240V	330°	0% 100%	E27	CRI ≥ 80
IP20	-5°C +40°C	30.000h	20.000	
UV free	Hg free	<1.0sec	50Hz	

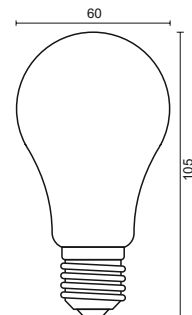

A

art.nr.:
ZLF512A

1 / 10 / 100



A

art.nr.:
ZLF522A

1 / 10 / 100



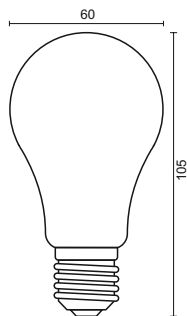
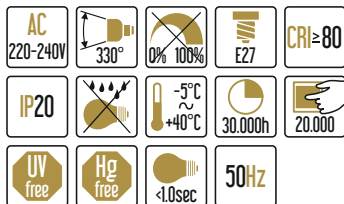

840Lm
(360°)

4000K



6W



D

art.nr.:
ZLF521

840Lm
(360°)

3000K



6W



D

art.nr.:
ZLF511

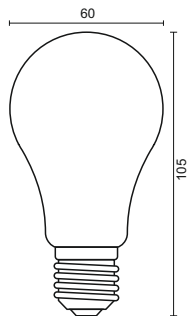
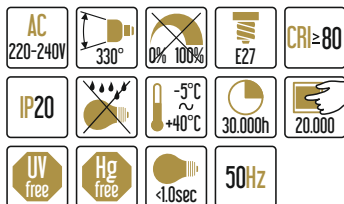

1120Lm
(360°)

4000K



8W



D

art.nr.:
ZLF522

1120Lm
(360°)

3000K



8W



D

art.nr.:
ZLF512

12W



1680lm
(360°)

3000K

12W



1680lm
(360°)

4000K

AC 220-240V	330°	0% 100%	E27	CRI ≥ 80
IP20	-5°C +40°C	30.000h	20.000	
UV free	Hg free	<1.0sec	50Hz	

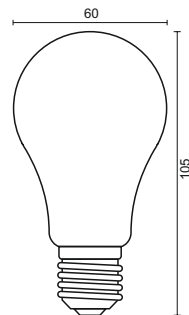

D

art.nr.:
ZLF513

1 / 10 / 100



D

art.nr.:
ZLF523

1 / 10 / 100



12W



1680lm
(360°)

3000K

12W



1680lm
(360°)

4000K

AC 220-240V	330°	0% 100%	E27	CRI ≥ 80
IP20	-5°C +40°C	30.000h	20.000	
UV free	Hg free	<1.0sec	50Hz	

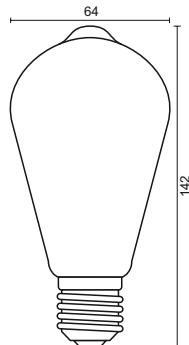

D

art.nr.:
ZLF915

1 / 10 / 50



D

art.nr.:
ZLF925

1 / 10 / 50



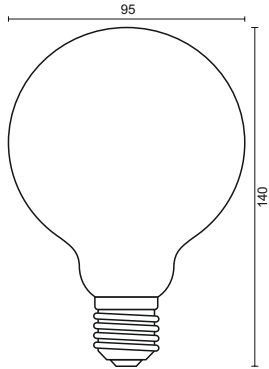
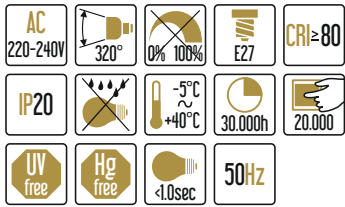

1520lm
(360°)

4000K



11W



D

art.nr.:
ZLF921

1520lm
(360°)

3000K



11W



D

art.nr.:
ZLF911

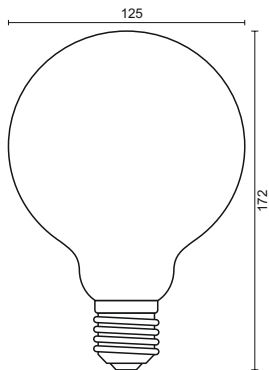
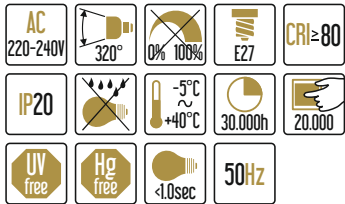

2460lm
(360°)

4000K



18W



D

art.nr.:
ZLF924

2460lm
(360°)

3000K



18W



D

art.nr.:
ZLF914

4W

560Lm
(360°)

3000K



4W

560Lm
(360°)

4000K



AC 220-240V	330°	0% 100%	E27	CRI ≥ 80
IP20		-5°C +40°C	30.000h	20.000
UV free	Hg free	<1.0sec	50Hz	

D

art.nr.:
ZLF817

1 / 10 / 100



D

art.nr.:
ZLF827

1 / 10 / 100

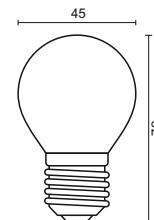

6W

840Lm
(360°)

3000K



6W

840Lm
(360°)

4000K



AC 220-240V	330°	0% 100%	E27	CRI ≥ 80
IP20		-5°C +40°C	30.000h	20.000
UV free	Hg free	<1.0sec	50Hz	

D

art.nr.:
ZLF818

1 / 10 / 100



D

art.nr.:
ZLF828

1 / 10 / 100

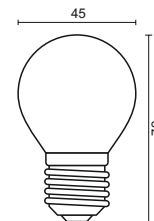

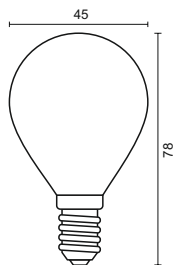
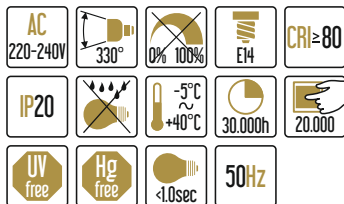

560Lm
(360°)

4000K



D

art.nr.:
ZLF822

4W

560Lm
(360°)

3000K



D

art.nr.:
ZLF812

4W

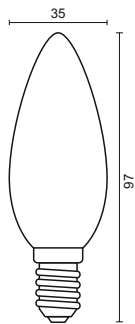
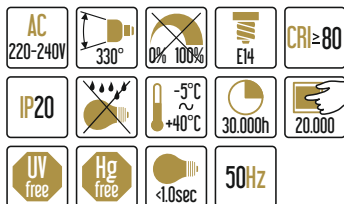

560Lm
(360°)

4000K



D

art.nr.:
ZLF722

4W

560Lm
(360°)

3000K



D

art.nr.:
ZLF712

4W

7.5W



840lm
(360°)
3000K
WHITE
Filament

7.5W



840lm
(360°)
4000K
WHITE
Filament



art.nr.:
ZWF101



1/50



art.nr.:
ZWF201



1/50

AC 220-240V	320°	0% 100%	E27	CRI ≥ 80
IP20	-5°C +40°C	30.000h	20.000	
UV free	Hg free	<1.0sec	50Hz	

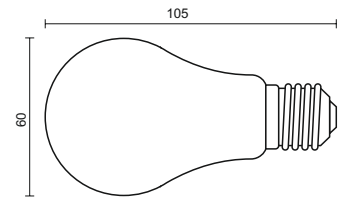

9W



1060lm
(360°)
3000K
WHITE
Filament

9W



1060lm
(360°)
4000K
WHITE
Filament



art.nr.:
ZWF102



1/50



art.nr.:
ZWF202



1/50

AC 220-240V	320°	0% 100%	E27	CRI ≥ 80
IP20	-5°C +40°C	30.000h	20.000	
UV free	Hg free	<1.0sec	50Hz	

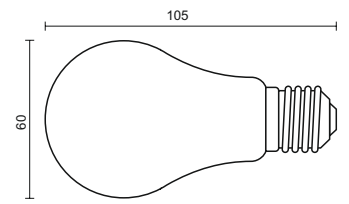

13W



1520lm
(360°)
3000K
WHITE
Filament

13W



1520lm
(360°)
4000K
WHITE
Filament



art.nr.:
ZWF103



1/50



art.nr.:
ZWF203



1/50

AC 220-240V	320°	0% 100%	E27	CRI ≥ 80
IP20	-5°C +40°C	30.000h	20.000	
UV free	Hg free	<1.0sec	50Hz	

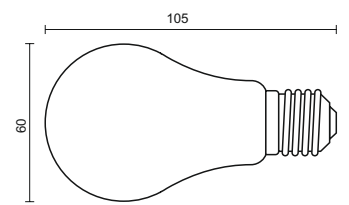

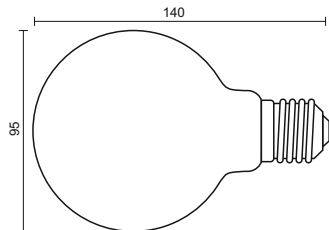
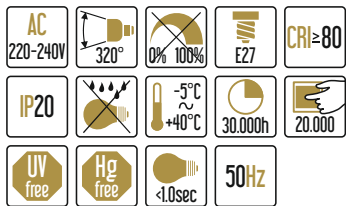

13W



E
art.nr.:
ZWF204



13W



E
art.nr.:
ZWF104

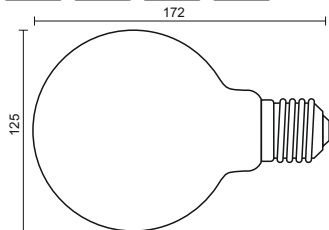
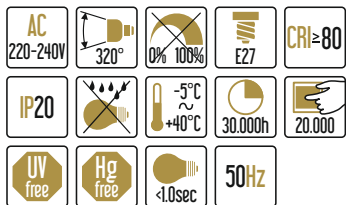

13W



E
art.nr.:
ZWF205



13W



E
art.nr.:
ZWF105

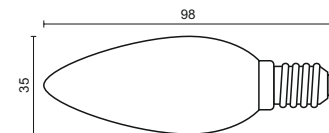
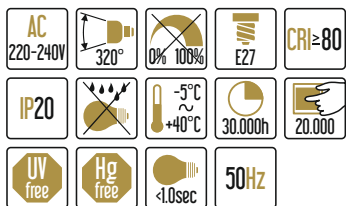

4.5W



F
art.nr.:
ZWF206



4.5W



F
art.nr.:
ZWF106

4.5W



art.nr.:
ZFS101



- 400Lm (360°)
- 1800K
- SLIM Filament
- VINTAGE

1 / 50

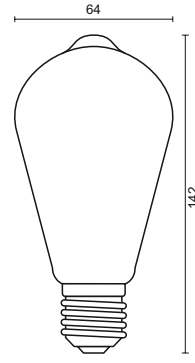

- AC 220-240V
- 320°
- 0% 100%
- E27
- CRI ≥ 80
- IP20
- 5°C ~ +40°C
- 30.000h
- 20.000
- UV free
- Hg free
- <1.0sec
- 50Hz

4.5W



art.nr.:
ZFS102



- 400Lm (360°)
- 1800K
- SLIM Filament
- VINTAGE

1 / 50

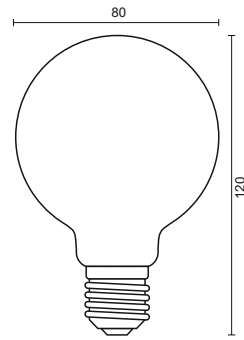

- AC 220-240V
- 320°
- 0% 100%
- E27
- CRI ≥ 80
- IP20
- 5°C ~ +40°C
- 30.000h
- 20.000
- UV free
- Hg free
- <1.0sec
- 50Hz

4.5W



art.nr.:
ZFS103



- 300Lm (360°)
- 1800K
- SLIM Filament
- VINTAGE

1 / 50

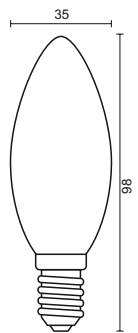

- AC 220-240V
- 320°
- 0% 100%
- E27
- CRI ≥ 80
- IP20
- 5°C ~ +40°C
- 30.000h
- 20.000
- UV free
- Hg free
- <1.0sec
- 50Hz

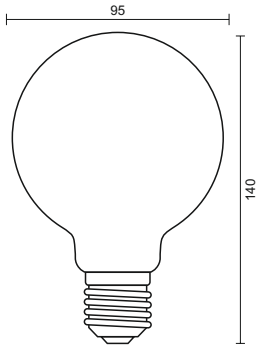
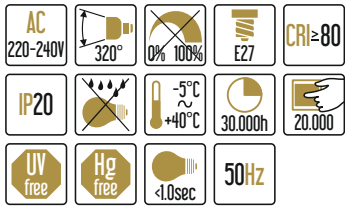

art.nr.:
ZAF101

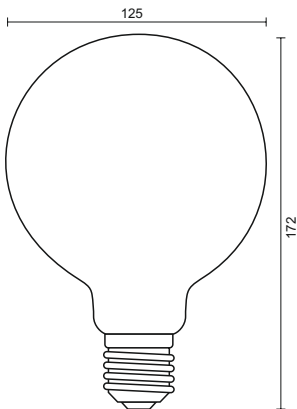
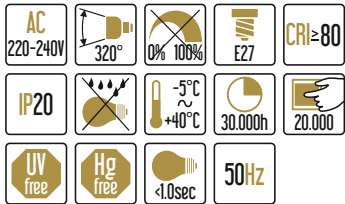

art.nr.:
ZAF102

4W



art.nr.:
ZBF101

250Lm
(360°)

2000K

SMOKE

AC
220-240V

320°

0% 100%

E27

CRI ≥ 80

IP20

-5°C
+40°C

30.000h

20.000

UV free

Hg free

<1.0sec

50Hz

1 / 50

8 585040 912862

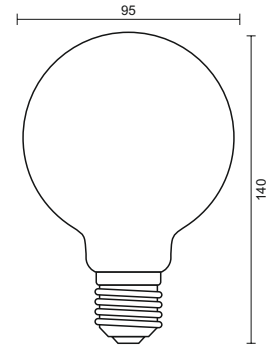

4W

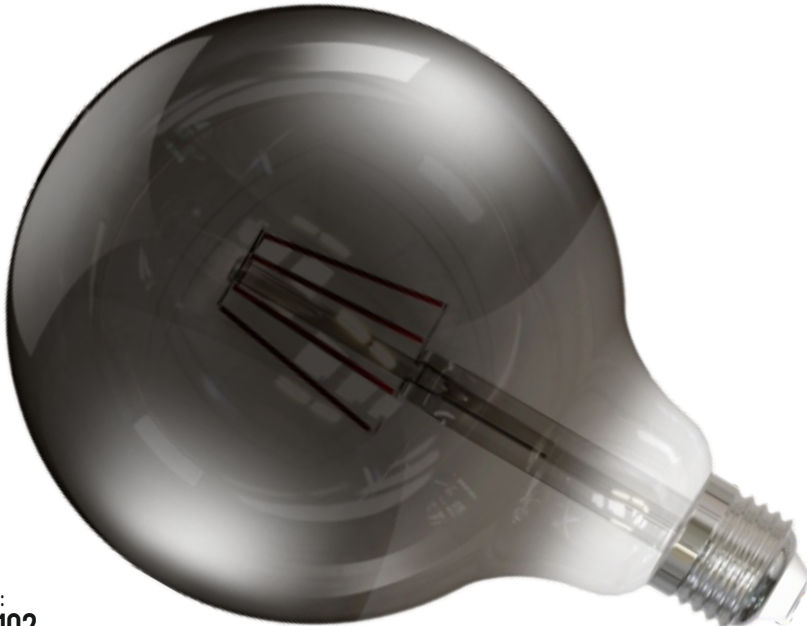

art.nr.:
ZBF102

250Lm
(360°)

2000K

SMOKE

AC
220-240V

320°

0% 100%

E27

CRI ≥ 80

IP20

-5°C
+40°C

30.000h

20.000

UV free

Hg free

<1.0sec

50Hz

1 / 20

8 585040 912879

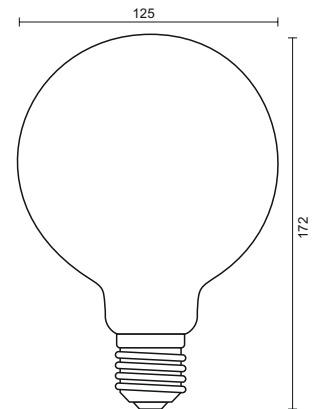

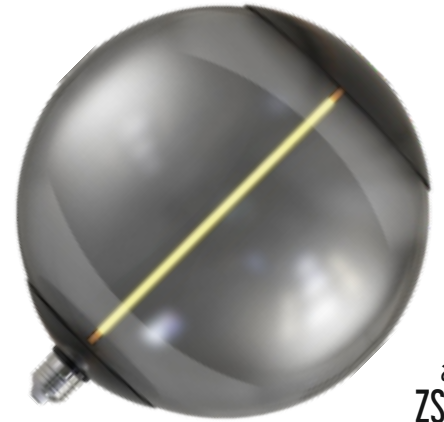
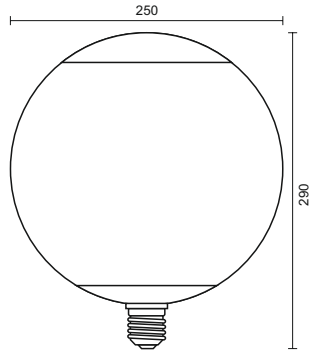
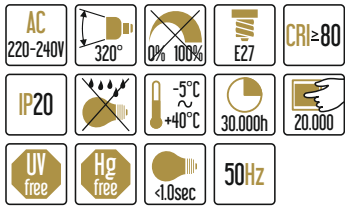

art.nr.:
ZSF101

4W

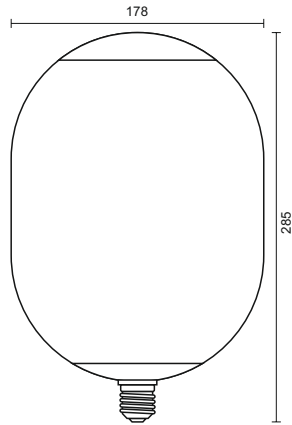
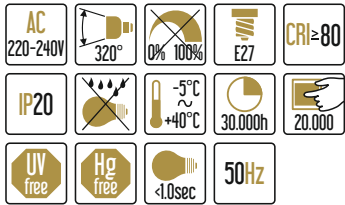

art.nr.:
ZSF102

4W

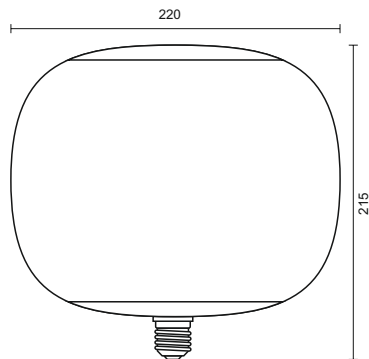
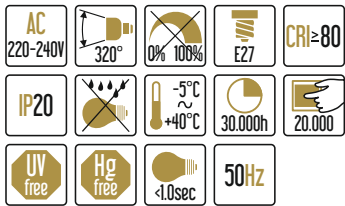

art.nr.:
ZSF103

4W

4W



- 100Lm (360°)
- 1800K
- SMOKE
- SHAPE

art.nr.: ZSF104



4W



- 100Lm (360°)
- 1800K
- BLUE
- SHAPE

art.nr.: ZSF105



- AC 220-240V
- 320°
- 0% 100%
- E27
- CRI ≥ 80
- IP20
- 5°C ~ +40°C
- 30.000h
- 20.000
- UV free
- Hg free
- <1.0sec
- 50Hz

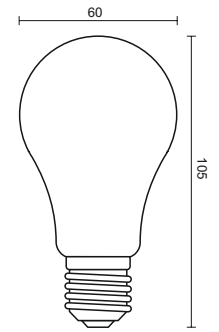

4W



- 100Lm (360°)
- 1800K
- YELLOW
- SHAPE

art.nr.: ZSF106



4W



- 100Lm (360°)
- 1800K
- BROWN
- SHAPE

art.nr.: ZSF107



- AC 220-240V
- 320°
- 0% 100%
- E27
- CRI ≥ 80
- IP20
- 5°C ~ +40°C
- 30.000h
- 20.000
- UV free
- Hg free
- <1.0sec
- 50Hz

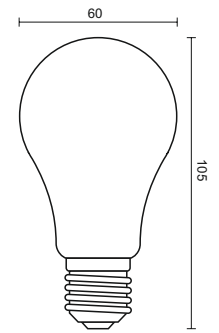

4W

AC 220-240V	320°	0% 100%	E27	CRI ≥ 80
IP20		-5°C +40°C	30.000h	20.000
UV free	Hg free	<1.0sec	50Hz	

100Lm
(360°)

1800K

SMOKE

SHAPE

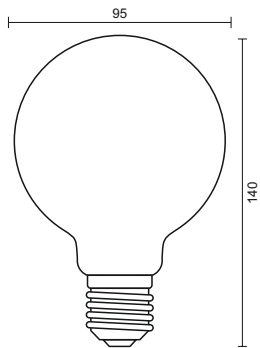

1 / 50

8 585040 912923



art.nr.:
ZSF108

4W

AC 220-240V	320°	0% 100%	E27	CRI ≥ 80
IP20		-5°C +40°C	30.000h	20.000
UV free	Hg free	<1.0sec	50Hz	

100Lm
(360°)

1800K

YELLOW

SHAPE

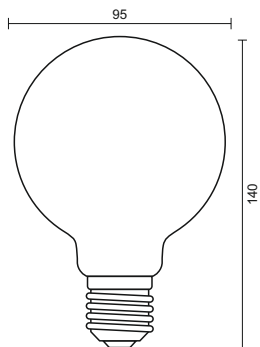

1 / 50

8 585040 912930



art.nr.:
ZSF109

4.9W

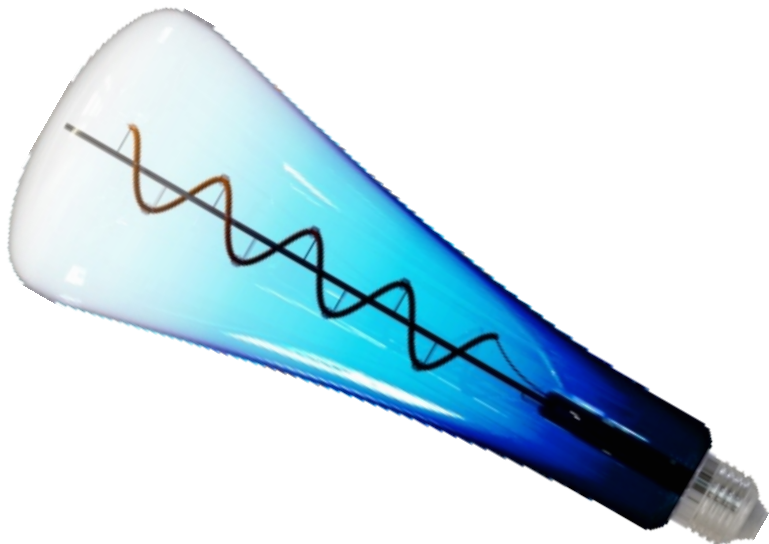

art.nr.: ZSF110

- 150Lm (360°)
- 1800K
- BLUE
- SHAPE
- AC 220-240V
- 320°
- 0% 100%
- E27
- CRI ≥ 80
- IP20
- 5°C ~ +40°C
- 30.000h
- 20.000
- UV free
- Hg free
- <1.0sec
- 50Hz

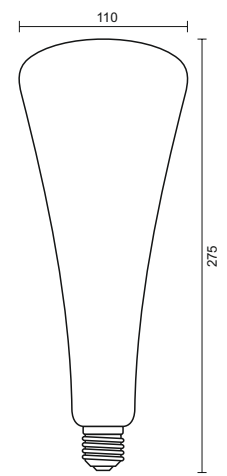

4.9W

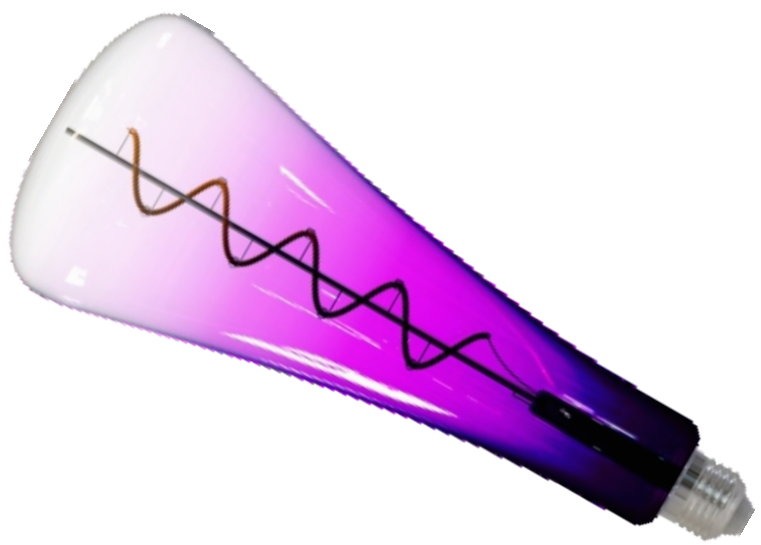

art.nr.: ZSF111

- 150Lm (360°)
- 1800K
- PURPLE
- SHAPE
- AC 220-240V
- 320°
- 0% 100%
- E27
- CRI ≥ 80
- IP20
- 5°C ~ +40°C
- 30.000h
- 20.000
- UV free
- Hg free
- <1.0sec
- 50Hz

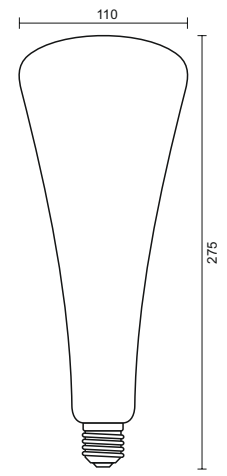

AC 220-240V	320°	0% 100%	E27	CRI ≥ 80
IP20		-5°C +40°C	30.000h	20.000
UV free	Hg free	<1.0sec	50Hz	

120Lm (360°)
2000K
VINTAGE
SHAPE

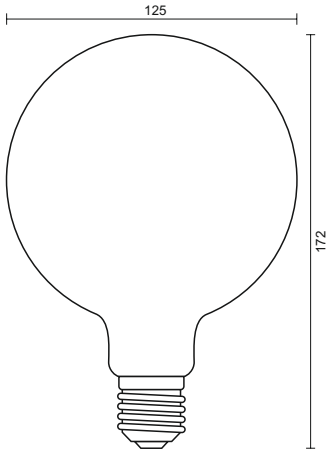

1 / 25



4W



art.nr.:
ZSF113

- 250Lm
(360°)
- 2000K
- VINTAGE
- SHAPE



- AC
220-240V
- 320°
- 0% 100%
- E27
- CRI ≥ 80
- IP20
- 5°C
+40°C
- 30.000h
- 20.000
- UV free
- Hg free
- <1.0sec
- 50Hz

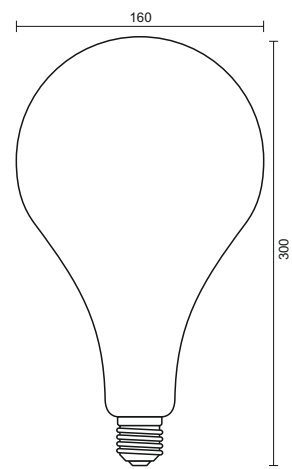

4W



art.nr.:
ZSF114

- 150Lm
(360°)
- 2000K
- SMOKY
- SHAPE



- AC
220-240V
- 320°
- 0% 100%
- E27
- CRI ≥ 80
- IP20
- 5°C
+40°C
- 30.000h
- 20.000
- UV free
- Hg free
- <1.0sec
- 50Hz

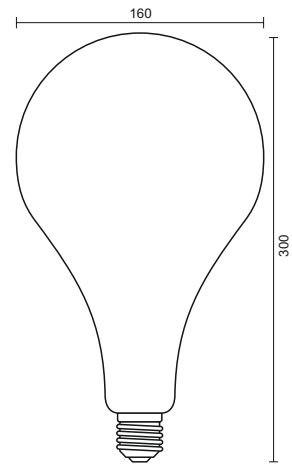

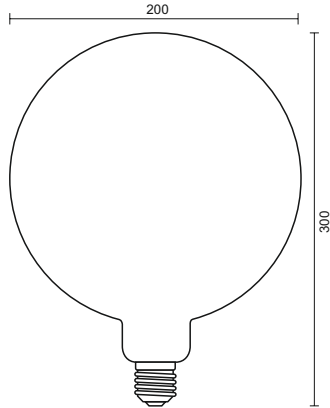
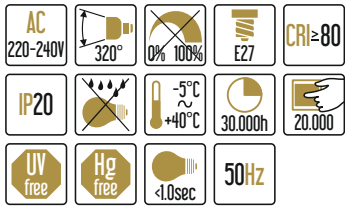

art.nr.:
ZSF115

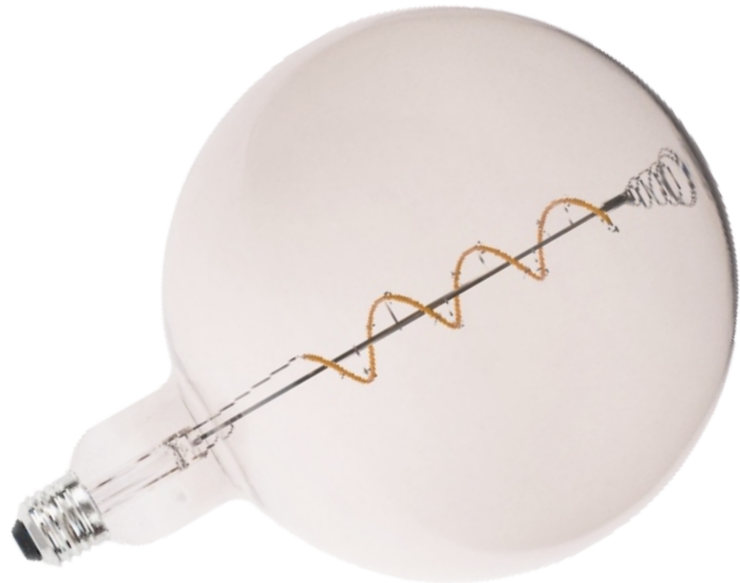
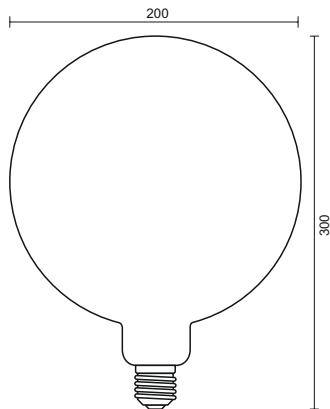
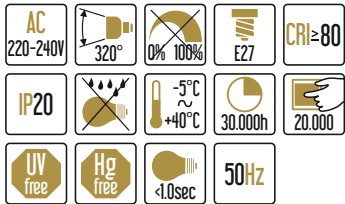

art.nr.:
ZSF116

4W

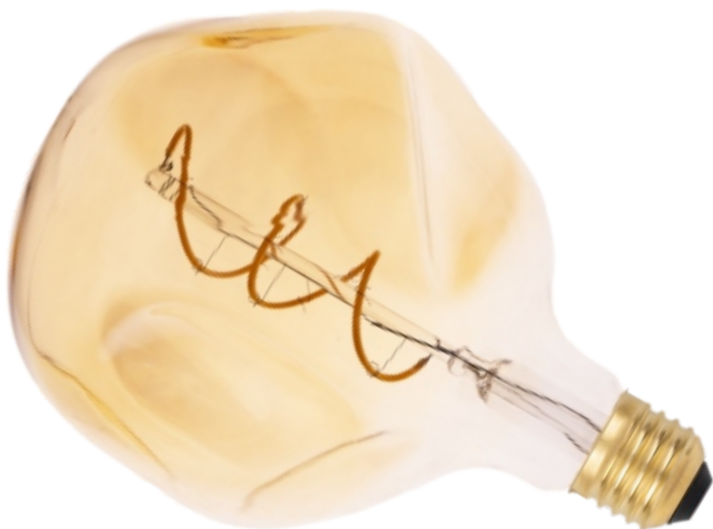

art.nr.:
ZSF117

- 250Lm (360°)
- 2000K
- VINTAGE
- SHAPE



- AC 220-240V
- 320°
- 0% 100%
- E27
- CRI ≥ 80
- IP20
- 5°C ~ +40°C
- 30.000h
- 20.000
- UV free
- Hg free
- <1.0sec
- 50Hz

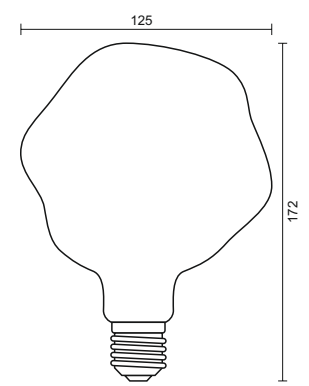

4W

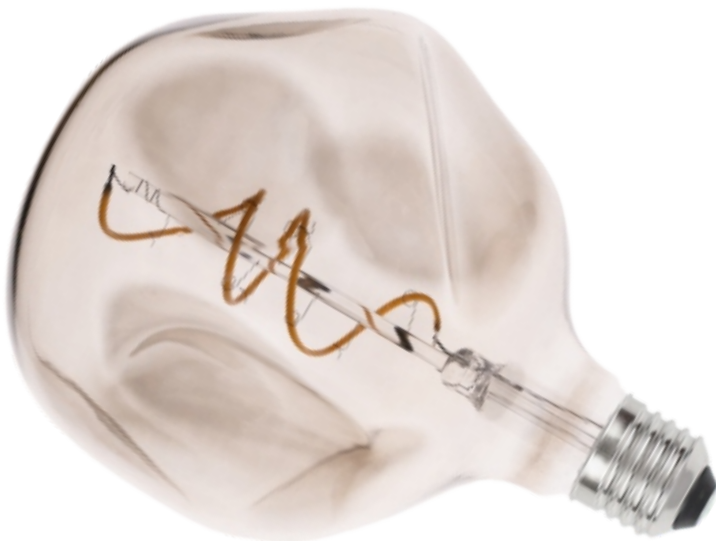

art.nr.:
ZSF118

- 150Lm (360°)
- 2000K
- SMOKY
- SHAPE



- AC 220-240V
- 320°
- 0% 100%
- E27
- CRI ≥ 80
- IP20
- 5°C ~ +40°C
- 30.000h
- 20.000
- UV free
- Hg free
- <1.0sec
- 50Hz

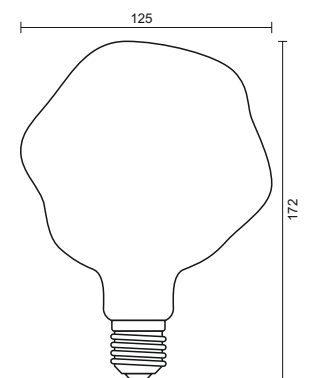

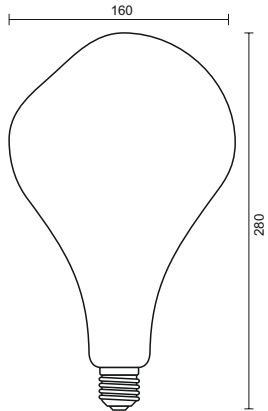
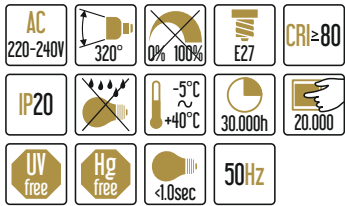

art.nr.:
ZSF119

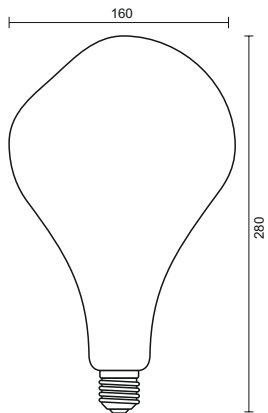
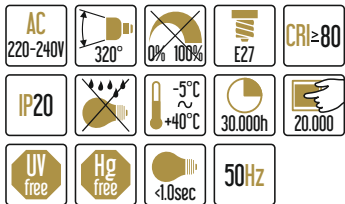

art.nr.:
ZSF120

4W



art.nr.:
ZSF121

- 250Lm
(360°)
- 2000K
- VINTAGE
- SHAPE



- AC
220-240V
- 320°
- 0% 100%
- E27
- CRI ≥ 80
- IP20
- 5°C
+40°C
- 30.000h
- 20.000
- UV free
- Hg free
- <1.0sec
- 50Hz

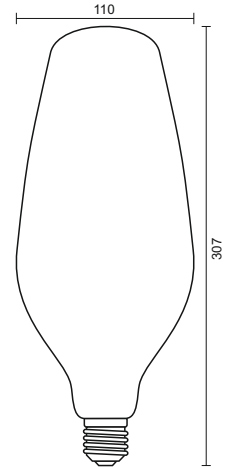

4W



art.nr.:
ZSF122

- 150Lm
(360°)
- 2000K
- SMOKY
- SHAPE



- AC
220-240V
- 320°
- 0% 100%
- E27
- CRI ≥ 80
- IP20
- 5°C
+40°C
- 30.000h
- 20.000
- UV free
- Hg free
- <1.0sec
- 50Hz

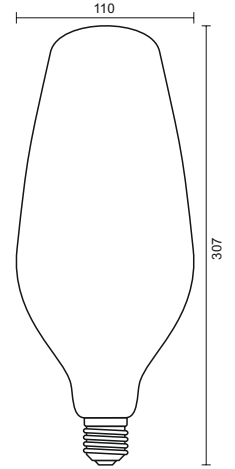

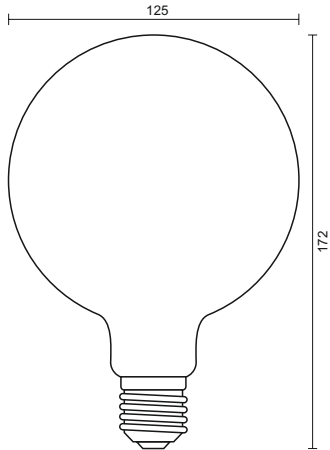
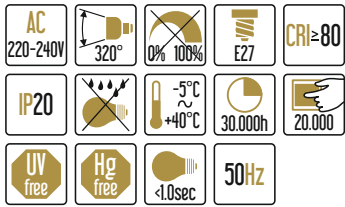

8 585040 913719

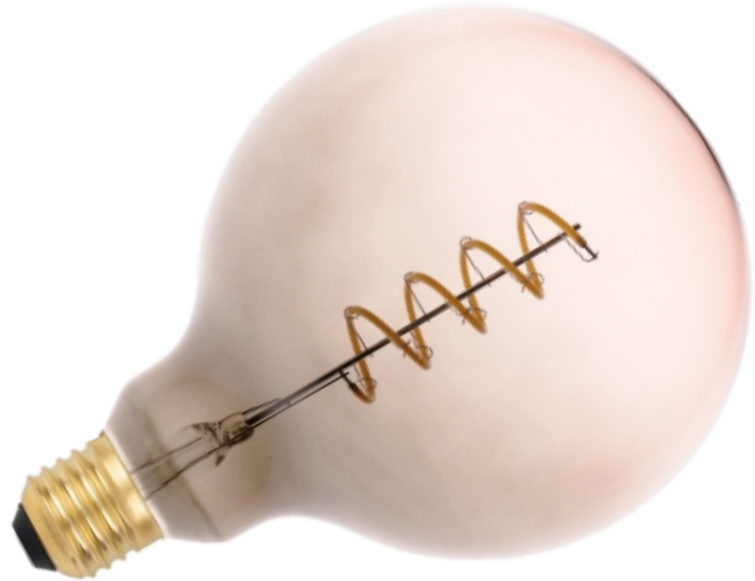

art.nr.:
ZSF123

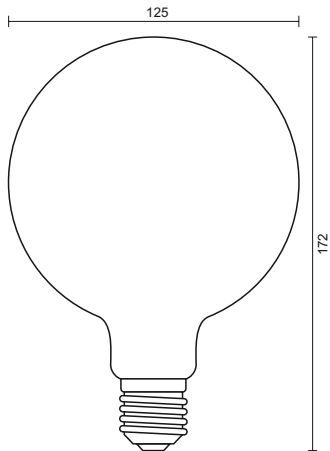
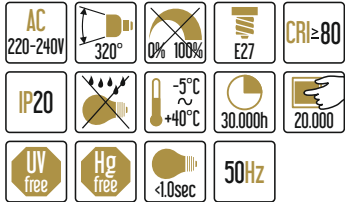

8 585040 913722

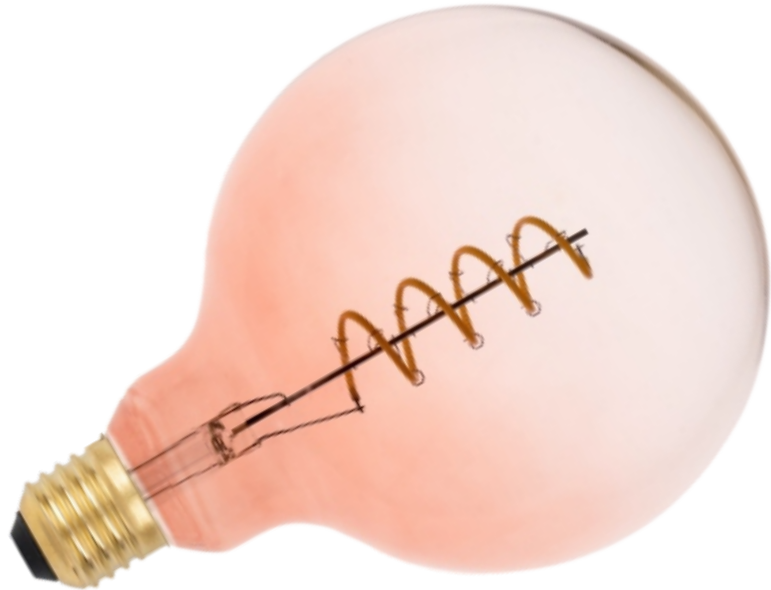

art.nr.:
ZSF124

7W

600Lm
(360°)
3000K



F
art.nr.:
ZLS571



7W

630Lm
(360°)
4000K



F
art.nr.:
ZLS581



7W

630Lm
(360°)
6500K



F
art.nr.:
ZLS561



AC 165-265V	300°	0% 100%	E27	CRI ≥ 80
IP20	-5°C +40°C	30.000h	20.000	
UV free	Hg free	<1.0sec	50Hz	

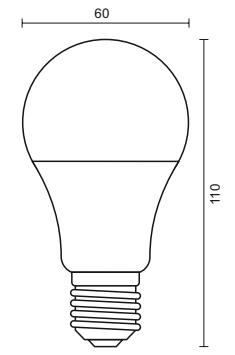

9W

830Lm
(360°)
3000K



F
art.nr.:
ZLS572



9W

830Lm
(360°)
4000K



F
art.nr.:
ZLS582



9W

840Lm
(360°)
6500K



F
art.nr.:
ZLS562



AC 165-265V	300°	0% 100%	E27	CRI ≥ 80
IP20	-5°C +40°C	30.000h	20.000	
UV free	Hg free	<1.0sec	50Hz	

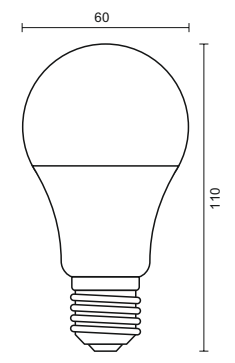

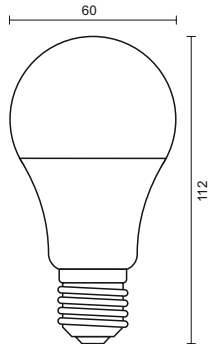
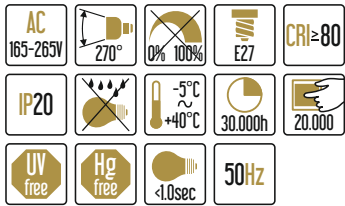

1170Lm
(360°)

6500K



1 / 10 / 100



F
art.nr.:
ZLS503

12W

1170Lm
(360°)

4000K



1 / 10 / 100



F
art.nr.:
ZLS523

12W

1160Lm
(360°)

3000K



1 / 10 / 100



F
art.nr.:
ZLS513

12W

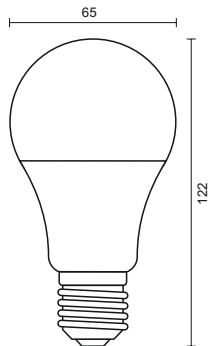
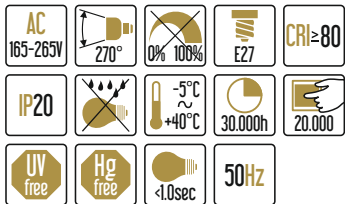

1380Lm
(360°)

6500K



1 / 10 / 100



F
art.nr.:
ZLS505

13.5W

1350Lm
(360°)

4000K



1 / 10 / 100



F
art.nr.:
ZLS525

13.5W

1320Lm
(360°)

3000K



1 / 10 / 100



F
art.nr.:
ZLS515

13.5W

18W



1830lm
(360°)

3000K

AC 165-265V	300°	0% 100%	E27	CRI ≥ 80
IP20	-5°C +40°C	30.000h	20.000	
UV free	Hg free	<1.0sec	50Hz	

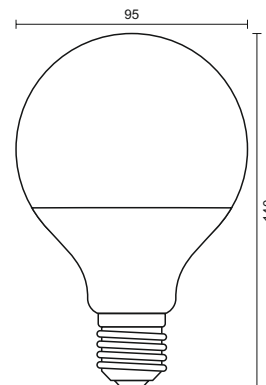

F

art.nr.:
ZLS912

1 / 32



18W



1840lm
(360°)

4000K

AC 165-265V	300°	0% 100%	E27	CRI ≥ 80
IP20	-5°C +40°C	30.000h	20.000	
UV free	Hg free	<1.0sec	50Hz	

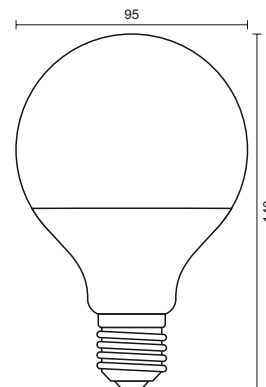

F

art.nr.:
ZLS922

1 / 32



20W

AC 165-265V	300°	0% 100%	E27	CRI ≥ 80
IP20		-5°C +40°C	30.000h	20.000
UV free	Hg free	<1.0sec	50Hz	

2050lm
(360°)

3000K

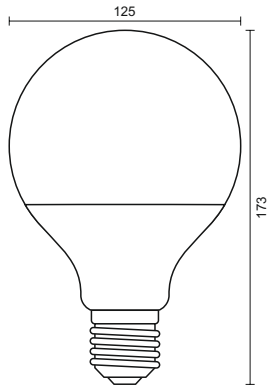

1 / 24

8 585040 905314

F

art.nr.:
ZLS914

20W

AC 165-265V	300°	0% 100%	E27	CRI ≥ 80
IP20		-5°C +40°C	30.000h	20.000
UV free	Hg free	<1.0sec	50Hz	

2100lm
(360°)

4000K

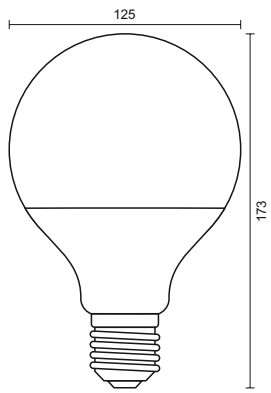

1 / 24

8 585040 905307

F

art.nr.:
ZLS924

5W

430Lm
(360°)
3000K



F
art.nr.:
ZLS712



5W

430Lm
(360°)
4000K



F
art.nr.:
ZLS722



5W

440Lm
(360°)
6500K



F
art.nr.:
ZLS702



AC 165-265V	160°	0% 100%	E14	CRI ≥ 80
IP20	-5°C +40°C	30.000h	20.000	
UV free	Hg free	<1.0sec	50Hz	

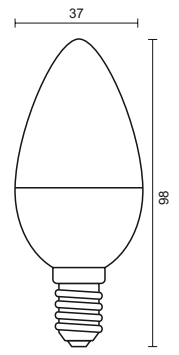

8W

710Lm
(360°)
3000K



F
art.nr.:
ZLS714



8W

720Lm
(360°)
4000K



F
art.nr.:
ZLS724



8W

720Lm
(360°)
6500K



F
art.nr.:
ZLS704



AC 165-265V	160°	0% 100%	E14	CRI ≥ 80
IP20	-5°C +40°C	30.000h	20.000	
UV free	Hg free	<1.0sec	50Hz	

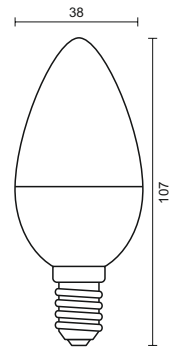

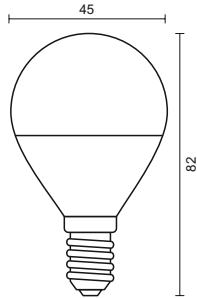
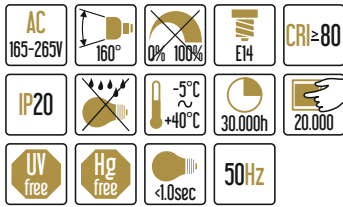

440Lm
(360°)

6500K



F
art.nr.:
ZLS802

5W

430Lm
(360°)

4000K



F
art.nr.:
ZLS822

5W

430Lm
(360°)

3000K



F
art.nr.:
ZLS812

5W

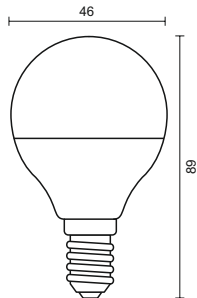
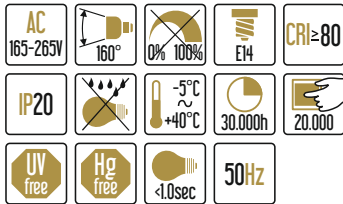

720Lm
(360°)

6500K



F
art.nr.:
ZLS804

8W

720Lm
(360°)

4000K



F
art.nr.:
ZLS824

8W

710Lm
(360°)

3000K



F
art.nr.:
ZLS814

8W

5W

430Lm
(360°)
3000K



5W

430Lm
(360°)
4000K



5W

440Lm
(360°)
6500K



AC 165-265V	160°	0% 100%	E27	CRI ≥ 80
IP20		-5°C +40°C	30.000h	20.000
UV free	Hg free	<1.0sec	50Hz	

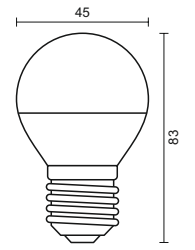

F
art.nr.:
ZLS817



F
art.nr.:
ZLS827



F
art.nr.:
ZLS807



8W

710Lm
(360°)
3000K



8W

720Lm
(360°)
4000K



8W

720Lm
(360°)
6500K



AC 165-265V	160°	0% 100%	E27	CRI ≥ 80
IP20		-5°C +40°C	30.000h	20.000
UV free	Hg free	<1.0sec	50Hz	

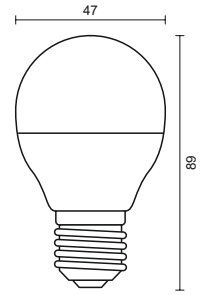

F
art.nr.:
ZLS819



F
art.nr.:
ZLS829



F
art.nr.:
ZLS809



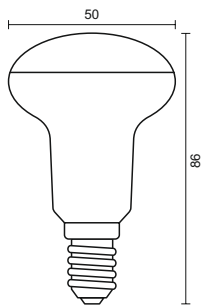
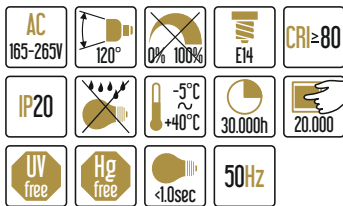

410Lm
(360°)

6500K



1 / 10 / 100



G
art.nr.:
ZLS203

5W

410Lm
(360°)

4000K



1 / 10 / 100



G
art.nr.:
ZLS223

5W

390Lm
(360°)

3000K



1 / 10 / 100



G
art.nr.:
ZLS213

5W

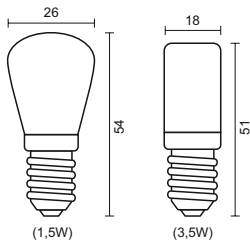
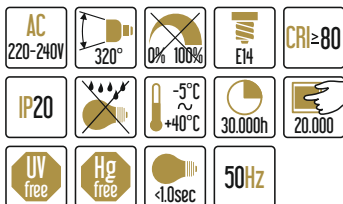

150Lm
(360°)

6000K



1 / 100 / 500



F
art.nr.:
ZLS001

1.5W

300Lm
(360°)

4000K



1 / 100 / 500



F
art.nr.:
ZLS021

3.5W

3W

230Lm
(360°)
3000K



3W

240Lm
(360°)
4000K



3W

250Lm
(360°)
6500K



AC 165-265V	120°	0% 100%	GU10	CRI ≥ 80
IP20		-5°C ~ +40°C	30.000h	20.000
UV free	Hg free	<1.0sec	50Hz	

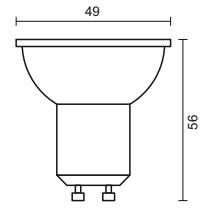

G
art.nr.:
ZLS112



G
art.nr.:
ZLS122



G
art.nr.:
ZLS102



6W

490Lm
(360°)
3000K



6W

490Lm
(360°)
4000K



6W

500Lm
(360°)
6500K



AC 165-265V	120°	0% 100%	GU10	CRI ≥ 80
IP20		-5°C ~ +40°C	30.000h	20.000
UV free	Hg free	<1.0sec	50Hz	

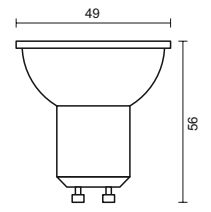

G
art.nr.:
ZLS116



G
art.nr.:
ZLS126



G
art.nr.:
ZLS106



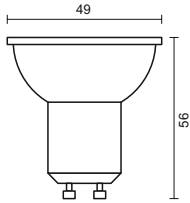
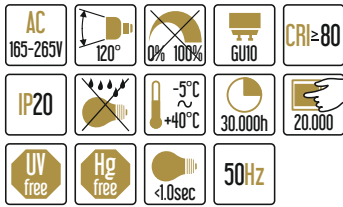

600Lm
(360°)

6500K



F

art.nr.:
ZLS107

7W

600Lm
(360°)

4000K



F

art.nr.:
ZLS127

7W

600Lm
(360°)

3000K



F

art.nr.:
ZLS117

7W

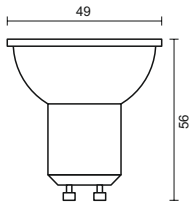
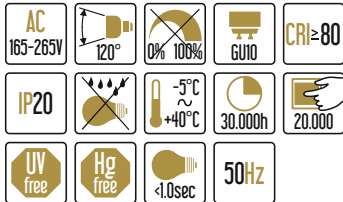

720Lm
(360°)

6500K



F

art.nr.:
ZLS108

8W

720Lm
(360°)

4000K



F

art.nr.:
ZLS128

8W

710Lm
(360°)

3000K



F

art.nr.:
ZLS118

8W

5W

5W



500Lm
(360°)

2800K

F

art.nr.:
ZLS012

1 / 100 / 500



520Lm
(360°)

4000K



F

art.nr.:
ZLS022

1 / 100 / 500

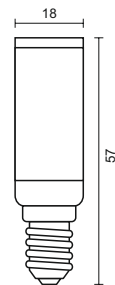
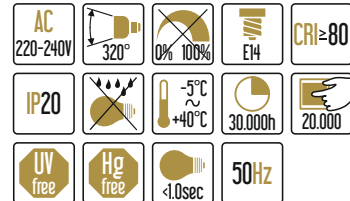

7W

7W



700Lm
(360°)

2800K

F

art.nr.:
ZLS013

1 / 100 / 500



730Lm
(360°)

4000K



F

art.nr.:
ZLS023

1 / 100 / 500

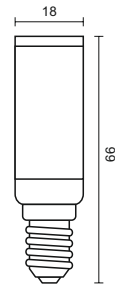
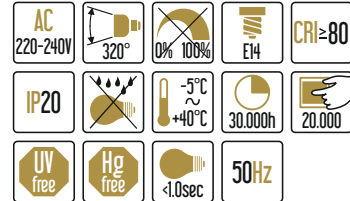

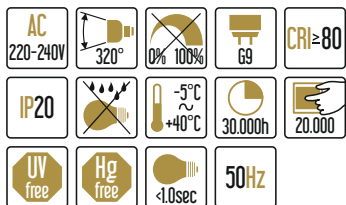

450Lm
(360°)

4000K



E

art.nr.:
ZLS624COB

450Lm
(360°)

2800K



E

art.nr.:
ZLS614COB

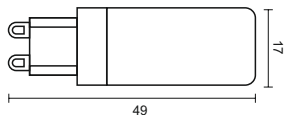
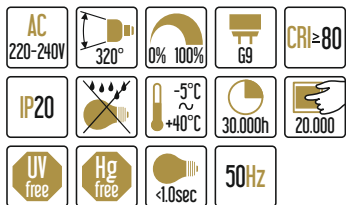

330Lm
(360°)

6000K

DIM



G

art.nr.:
ZLS604CD

330Lm
(360°)

4000K

DIM



G

art.nr.:
ZLS624CD

320Lm
(360°)

2800K

DIM



G

art.nr.:
ZLS614CD

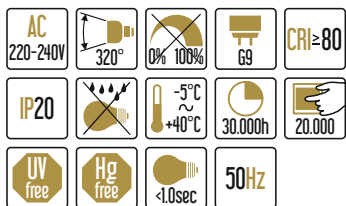

330Lm
(360°)

6000K



G

art.nr.:
ZLS604C

330Lm
(360°)

4000K



G

art.nr.:
ZLS624C

320Lm
(360°)

2800K



G

art.nr.:
ZLS614C

5W

480Lm
(360°)

2800K



5W

500Lm
(360°)

4000K



AC 220-240V	320°	0% 100%	G9	CRI ≥ 80
IP20		-5°C ~ +40°C	30.000h	20.000
UV free	Hg free	<1.0sec	50Hz	

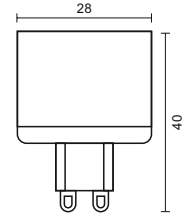

F

art.nr.:
ZLS615CW

1 / 100 / 400



F

art.nr.:
ZLS625CW

1 / 100 / 400



5W

500Lm
(360°)

2800K



5W

520Lm
(360°)

4000K



AC 220-240V	320°	0% 100%	G9	CRI ≥ 80
IP20		-5°C ~ +40°C	30.000h	20.000
UV free	Hg free	<1.0sec	50Hz	

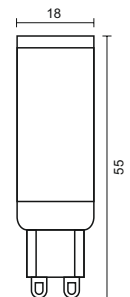

F

art.nr.:
ZLS615C

1 / 100 / 500



F

art.nr.:
ZLS625C

1 / 100 / 500



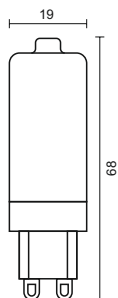
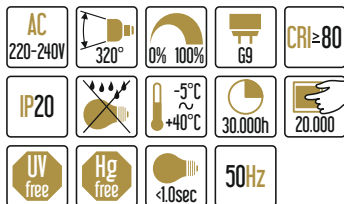

1 / 100 / 500



F
art.nr.:
ZLS606CD

6W



1 / 100 / 500



F
art.nr.:
ZLS626CD

6W



1 / 100 / 500



F
art.nr.:
ZLS616CD

6W

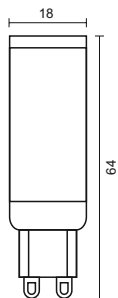
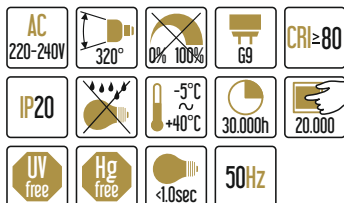

1 / 100 / 500



F
art.nr.:
ZLS606C

7W



1 / 100 / 500



F
art.nr.:
ZLS626C

7W



1 / 100 / 500



F
art.nr.:
ZLS616C

7W

1.5W



F

art.nr.:
ZLS421

140Lm
(360°)
4000K

AC/DC 12V	320°	0% 100%	G4	CRI ≥ 80
IP20		-5°C ~ +40°C	30.000h	20.000
UV free	Hg free	<1.0sec	50Hz	

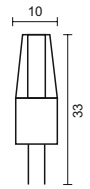

2W



G

art.nr.:
ZLS410

130Lm
(360°)
2800K

2W



G

art.nr.:
ZLS420

140Lm
(360°)
4000K

AC/DC 12V	320°	0% 100%	G4	CRI ≥ 80
IP20		-5°C ~ +40°C	30.000h	20.000
UV free	Hg free	<1.0sec	50Hz	

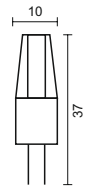

2W



E

art.nr.:
ZLS422

240Lm
(360°)
4000K

3W



F

art.nr.:
ZLS423

320Lm
(360°)
4000K

AC/DC 12V	320°	0% 100%	G4	CRI ≥ 80
IP20		-5°C ~ +40°C	30.000h	20.000
UV free	Hg free	<1.0sec	50Hz	

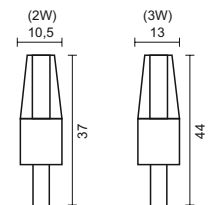

2W

AC/DC 12V	320°	0% 100%	64	CRI ≥ 80
IP20		-5°C +40°C	30.000h	20.000
UV free	Hg free	<1.0sec	50Hz	

240Lm (360°)
4000K
DIM

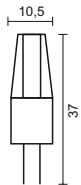

1 / 100 / 1000

8 585040 910035

E

art.nr.:
ZLS422CD

AC/DC 12V	120°	0% 100%	GU5.3	CRI ≥ 80
IP20		-5°C +40°C	30.000h	20.000
UV free	Hg free	<1.0sec	50Hz	

450Lm (360°)
4000K

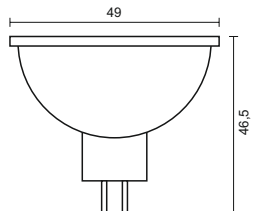

1 / 10 / 100

8 585040 902993

G
art.nr.:
ZLS323

440Lm (360°)
3000K



1 / 10 / 100

8 585040 903259

G
art.nr.:
ZLS313

9W



970Lm
(360°)
4100K

9W



980Lm
(360°)
6500K

AC 100-240V	300°	0% 100%	G13	CRI ≥ 80
IP20		-20°C +45°C	30.000h	20.000
UV free	Hg free	<1.0sec	50Hz	



F
art.nr.:
TLS221



F
art.nr.:
TLS201



18W



1850Lm
(360°)
4100K

18W



1870Lm
(360°)
6500K

AC 100-240V	300°	0% 100%	G13	CRI ≥ 80
IP20		-20°C +45°C	30.000h	20.000
UV free	Hg free	<1.0sec	50Hz	

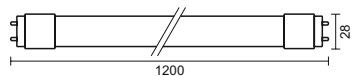

F
art.nr.:
TLS222



F
art.nr.:
TLS202



22W



2350Lm
(360°)
4100K

22W



2380Lm
(360°)
6500K

AC 100-240V	300°	0% 100%	G13	CRI ≥ 80
IP20		-20°C +45°C	30.000h	20.000
UV free	Hg free	<1.0sec	50Hz	



F
art.nr.:
TLS223



F
art.nr.:
TLS203



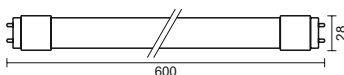
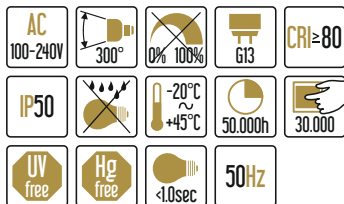

1350_{lm}
(360°)
6500K



D
art.nr.:
TLS301



1350_{lm}
(360°)
4100K



D
art.nr.:
TLS321

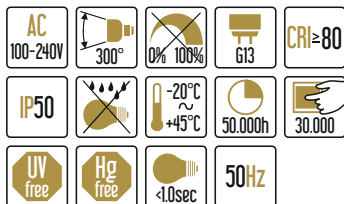

2700_{lm}
(360°)
6500K



D
art.nr.:
TLS302



2700_{lm}
(360°)
4100K



D
art.nr.:
TLS322

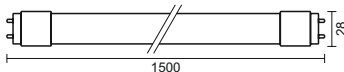
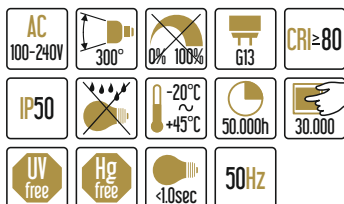

3300_{lm}
(360°)
6500K



D
art.nr.:
TLS303



3300_{lm}
(360°)
4100K



D
art.nr.:
TLS323



18W



art.nr.:
TLS4229

2880_{lm}
(360°)
4100K
Pf≥0.9



AC 100-240V	300°	0% 100%	G13	CRI≥80
IP20		50.000h	30.000	
UV free	Hg free	<1.0sec	50Hz	

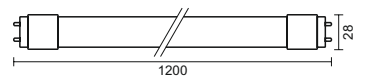

18W

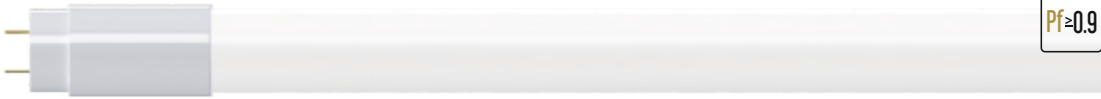

art.nr.:
TLS5229

3060_{lm}
(360°)
4100K
Pf≥0.9



AC 100-240V	300°	0% 100%	G13	CRI≥80
IP20		50.000h	30.000	
UV free	Hg free	<1.0sec	50Hz	Pf≥0.9

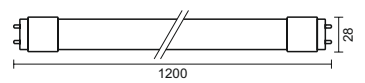

18W

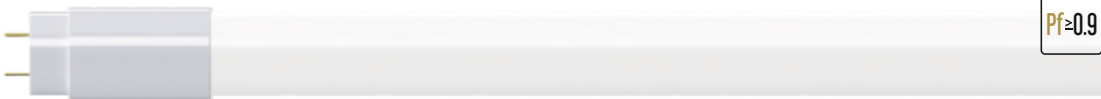

art.nr.:
TLS6229

3240_{lm}
(360°)
4100K
Pf≥0.9



AC 100-240V	300°	0% 100%	G13	CRI≥80
IP20		50.000h	30.000	
UV free	Hg free	<1.0sec	50Hz	Pf≥0.9

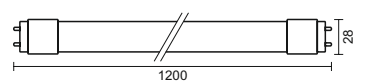

max
60W

PVC

E27

B-HOLDERS



1 / 50 / 500



art.nr.:
BH211

1 / 50 / 500



art.nr.:
BH201

B-HOLDERS

max
60W

CERAMIC

E27

B-HOLDERS



1 / 20 / 200



art.nr.:
BH203

G10

15cm

B-HOLDERS



1 / 100 / 1000



art.nr.:
BH101

CABLE TIES

UV SIZE
100mm / 2.5mm

CABLE TIES

UV SIZE
100mm / 2.5mm

max∅ 22mm UL 94V-2 PA6.6 -20°C ~ +85°C Halogen free



art.nr.:
T2100UV



art.nr.:
T2101UV

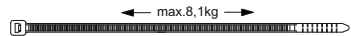

CABLE TIES

UV SIZE
140mm / 2.5mm

CABLE TIES

UV SIZE
140mm / 2.5mm

max∅ 33mm UL 94V-2 PA6.6 -20°C ~ +85°C Halogen free



art.nr.:
T2140UV



art.nr.:
T2141UV



CABLE TIES

UV SIZE
200mm / 2.5mm

max∅ 53mm UL 94V-2 PA6.6 -20°C ~ +85°C Halogen free



art.nr.:
T2200UV



CABLE TIES

UV SIZE
140mm / 3.6mm

CABLE TIES

UV SIZE
140mm / 3.6mm

max∅ 33mm UL 94V-2 PA6.6 -20°C ~ +85°C Halogen free



art.nr.:
T3140UV



art.nr.:
T3141UV

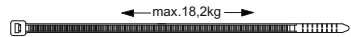

max∅ 53mm UL 94V-2 PA6.6 -20°C ~ +85°C Halogen free

SIZE 200mm / 3.6mm UV

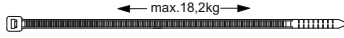

1 / 200

art.nr.: T3200UV

max∅ 65mm UL 94V-2 PA6.6 -20°C ~ +85°C Halogen free

SIZE 250mm / 3.6mm UV

SIZE 250mm / 3.6mm UV



1 / 200

art.nr.: T3251UV

1 / 200

art.nr.: T3250UV

max∅ 76mm UL 94V-2 PA6.6 -20°C ~ +85°C Halogen free

SIZE 300mm / 3.6mm UV



1 / 170

art.nr.: T3300UV

max∅ 53mm UL 94V-2 PA6.6 -20°C ~ +85°C Halogen free

SIZE 400mm / 4.8mm UV

SIZE 400mm / 4.8mm UV

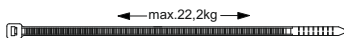

1 / 150

art.nr.: T4201UV

1 / 150

art.nr.: T4200UV

CABLE TIES

UV SIZE
250mm / 4.8mm

CABLE TIES

UV SIZE
250mm / 4.8mm

max∅ 65mm UL 94V-2 PA6.6 -20°C ~ +85°C Halogen free



art.nr.:
T4250UV



art.nr.:
T4251UV



CABLE TIES

UV SIZE
300mm / 4.8mm

CABLE TIES

UV SIZE
300mm / 4.8mm

max∅ 76mm UL 94V-2 PA6.6 -20°C ~ +85°C Halogen free



art.nr.:
T4300UV



art.nr.:
T4301UV



CABLE TIES

UV SIZE
370mm / 4.8mm

CABLE TIES

UV SIZE
370mm / 4.8mm

max∅ 102mm UL 94V-2 PA6.6 -20°C ~ +85°C Halogen free



art.nr.:
T4370UV



art.nr.:
T4371UV



CABLE TIES

UV SIZE
430mm / 4.8mm

CABLE TIES

UV SIZE
430mm / 4.8mm

max∅ 125mm UL 94V-2 PA6.6 -20°C ~ +85°C Halogen free



art.nr.:
T4430UV



art.nr.:
T4431UV



max∅ 53mm	UL 94V-2	PA6.6	-20°C ~ +85°C	Halogen free
--------------	-------------	-------	---------------------	--------------

SIZE 200mm / 76mm	UV
----------------------	----

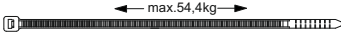

1 / 70



art.nr.:
T7201UV

max∅ 65mm	UL 94V-2	PA6.6	-20°C ~ +85°C	Halogen free
--------------	-------------	-------	---------------------	--------------

SIZE 250mm / 76mm	UV
----------------------	----



1 / 60



art.nr.:
T7251UV

max∅ 295mm	UL 94V-2	PA6.6	-20°C ~ +85°C	Halogen free
---------------	-------------	-------	---------------------	--------------

SIZE 1030mm / 12.6mm	UV
-------------------------	----



1 / 6



art.nr.:
T12031UV

UL 94V-2	PA6.6	-20°C ~ +85°C	Halogen free
-------------	-------	---------------------	--------------

max∅ 50mm	SIZE 200mm / 76mm	UV
--------------	----------------------	----

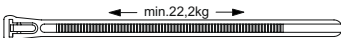

1 / 50



art.nr.:
TR7301UV

max∅ 80mm	SIZE 300mm / 76mm	UV
--------------	----------------------	----

1 / 70



art.nr.:
TR7201UV

ACCESS



art.nr.:
TH01

UV
SIZE
40.5mm / 20mm



UL
94V-2
PA6.6
-20°C ~ +85°C
Halogen free

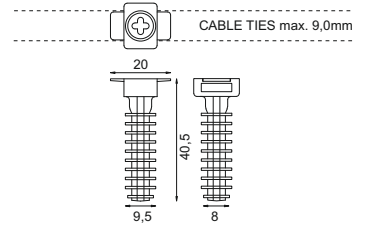

ACCESS



UV
SIZE
14.9 x 9.5 x 72mm



art.nr.:
TMS01

ACCESS



UV
SIZE
14.9 x 9.5 x 72mm



art.nr.:
TMS01/BK

UL
94V-2
PA6.6
-20°C ~ +85°C
Halogen free

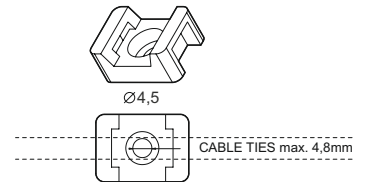

ACCESS



UV
SIZE
21.9 x 15.9 x 9.7mm



art.nr.:
TMS02

ACCESS



UV
SIZE
21.9 x 15.9 x 9.7mm



art.nr.:
TMS02/BK

UL
94V-2
PA6.6
-20°C ~ +85°C
Halogen free

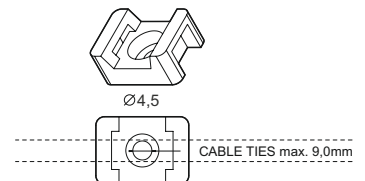



ACCESS

ACCESS

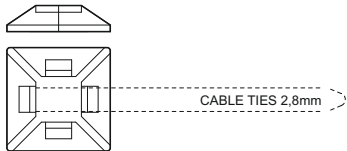

CABLE TIES 2,8mm



art.nr:
TMA1212/BK



art.nr:
TMA1212



ACCESS

ACCESS

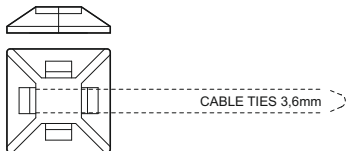

CABLE TIES 3,6mm



art.nr:
TMA1919/BK



art.nr:
TMA1919



ACCESS

ACCESS

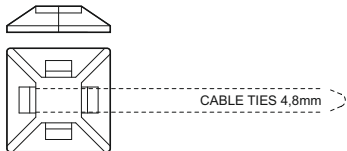

CABLE TIES 4,8mm



art.nr:
TMA2828/BK



art.nr:
TMA2828



SIZE
15mm / 10m



1 / 10 / 600



art.nr.:
TP1510/BK



SIZE
15mm / 10m



1 / 10 / 600



art.nr.:
TP1510/BL



SIZE
15mm / 10m



1 / 10 / 600



art.nr.:
TP1510/BR



SIZE
15mm / 10m



1 / 10 / 600



art.nr.:
TP1510/GR



SIZE
15mm / 10m



1 / 10 / 600



art.nr.:
TP1510/RD



SIZE
15mm / 10m



1 / 10 / 600



art.nr.:
TP1510/WH



SIZE
15mm / 10m



1 / 10 / 600



art.nr.:
TP1510/YE



SIZE
15mm / 10m



1 / 10 / 600



art.nr.:
TP1510/YG





SIZE
19mm / 10m



1 / 10 / 300



art.nr.:
TP1910/BL

INS. TAPES

SIZE
19mm / 10m



1 / 10 / 300



art.nr.:
TP1910/BK

INS. TAPES



SIZE
19mm / 10m



1 / 10 / 300



art.nr.:
TP1910/GR

INS. TAPES

SIZE
19mm / 10m



1 / 10 / 300



art.nr.:
TP1910/BR

INS. TAPES



SIZE
19mm / 10m



1 / 10 / 300



art.nr.:
TP1910/WH

INS. TAPES

SIZE
19mm / 10m



1 / 10 / 300



art.nr.:
TP1910/RD

INS. TAPES



SIZE
19mm / 10m



1 / 10 / 300



art.nr.:
TP1910/YG

INS. TAPES

SIZE
19mm / 10m



1 / 10 / 300



art.nr.:
TP1910/Y

INS. TAPES



SIZE
19mm / 20m



1 / 10 / 300



art.nr.:
TP1920/BK



SIZE
19mm / 20m



1 / 10 / 300



art.nr.:
TP1920/BL



SIZE
19mm / 20m



1 / 10 / 300



art.nr.:
TP1920/BR



SIZE
19mm / 20m



1 / 10 / 300



art.nr.:
TP1920/GR



SIZE
19mm / 20m



1 / 10 / 300



art.nr.:
TP1920/RD



SIZE
19mm / 20m



1 / 10 / 300



art.nr.:
TP1920/YE



SIZE
19mm / 20m



1 / 10 / 300



art.nr.:
TP1920/YG



0.13mm PVC 40kV -25°C ~ +90°C

SIZE
25mm / 10m



1 / 10 / 300



art.nr.:
TP2510/BK

0.13mm PVC 40kV -25°C ~ +90°C

SIZE
38mm / 10m



1 / 6 / 180



art.nr.:
TP3810/BK

0.13mm PVC 40kV -25°C ~ +90°C

SIZE
50mm / 10m



1 / 5 / 150



art.nr.:
TP5010/BK

AAS02	23	DL4305/B	86	L7736	63	LCL535LW	48
AAS03	23	DL4306/B	86	LC902AS/BK	12	LCL535S	42
AAS11	18	DL5301/S	87	LC902AS/GD	12	LCL535S/S	43
AS02	23	DL5302/B	88	LC902AS/SI	11	LCL536AD	46
BH101	185	DL5303/B	88	LC902AS/WH	11	LCL536AS	44
BH201	185	DL6401	89	LC902BB	16	LCL536AU	45
BH203	185	EK126	68	LC902C	10	LCL536S	42
BH211	185	FCL01	90	LC902I	13	LCL536S/S	43
CAP1	121	FCL02	90	LC902IB	13	LCL554B	49
CU21/60	28	FLO4R	91	LC902JB	17	LCL555B	49
CU21/120	28	FLO5R	91	LC902MB	15	LCL6340	50
CU22/60	28	FLO6R	92	LC902MB/S	15	LCL6341	50
CU22/120	28	FLO7R	92	LC902SS	16	LCL6342	50
CU23/60	28	FS03R	93	LC902Y	14	LCL6343	51
CU23/120	28	HE01	34	LC902YB	14	LCL6344	51
CU31/60	30	HE02	34	LC912R	17	LCL6345	51
CU31/120	30	HE03	34	LC912T	10	LCL6346	52
CU32/60	30	HFO1	79	LC942W	09	LCL6347	52
CU32/120	30	HFO2	79	LC951U	09	LCL6350	53
CU33/60	30	HFO2B	79	LCL421	38	LCL6351	53
CU33/120	30	HFO3	79	LCL421/44	39	LCL6352	53
CW132	125	HFO3B	79	LCL421M	38	LDL143	60
CW133	125	HFO4	79	LCL421M/44	39	LDL143/S	60
CW134	125	HFO4B	79	LCL421P	39	LDL153	60
DD126	68	HU12	24	LCL421S	38	LDL153/B	60
DL1201/W	80	HU21	28	LCL422M/44	40	LDL153/S	60
DL1202/W	80	HU22	28	LCL422S	40	LDL153/WL	60
DL1203/B	81	HU23	28	LCL422S/44	40	LDL154	61
DL1204/W	81	HU31	30	LCL423S	41	LDL154S	61
DL1205/W	82	HU32	30	LCL424S	41	LDL163W	07
DL1207/W	82	HU33	30	LCL533S	42	LDL163/SW	07
DL2301/B	83	L51015	56	LCL534AD	46	LDL164/SW	07
DL2301/W	83	L51036	56	LCL534AS	44	LDL164/W	07
DL3205/W	87	L51050	56	LCL534AU	45	LDL253	62
DL3304/W	84	L51515	57	LCL534BT	47	LDL253/S	62
DL3401/W	83	L51536	57	LCL534LW	48	LDL321	58
DL4301/B	84	L51550	57	LCL534S	42	LDL321B	59
DL4301/W	84	L70715	63	LCL534S/S	43	LDL321BG	59
DL4303/W	85	L70724	63	LCL535AD	46	LDL321BS	59
DL4304/B	85	L70736	63	LCL535AS	44	LDL321WB	58
DL4304/W	85	L71715	63	LCL535AU	45	LDL321WG	58
		L71724	63	LCL535BT	47	LDL321WS	58

LDL721	63	LF7023S	139	LH02R	98		
LDL722	63	LF7024	136	LH03R	98	LPL123	110
LEL101	32	LF7024S	139	LH04R	99	LPL124	111
LEL201	32	LF7025	137	LH05R	99	LPL125	111
LEL202	33	LF7121	135	LH06R	100	LPL131W	08
LEL203	33	LF7121S	138	LH07R	100	LPL133W	08
LEL204	34	LF7122	135	LM102	101	LPL211	112
LEL301	35	LF7122S	138	LNL121/1	65	LPL213	112
LEL401	35	LF7123	136	LNL122/1	65	LPL214	113
LEL501	36	LF7123S	139	LNL122/2	66	LPL215	113
LEL502	36	LF7124	136	LNL122/3	66	LPL221	112
LEL601	37	LF7124S	139	LNL123A	67	LPL223	112
LEL602	37	LFL110	118	LNL123/1	67	LPL224	113
LF0021	130	LFL111	118	LNL124	67	LPL225	113
LF0021S	132	LFL112	119	LNL125	68	LPL231W	08
LF0022	130	LFL113	120	LNL126	68	LPL233W	08
LF0022S	132	LFL114	120	LNL134W	06	LPL321	114
LF0023	130	LFL120	118	LNL322	72	LPL323	114
LF0023S	132	LFL121	118	LNL322/1	72	LPL324	115
LF0024	130	LFL122	119	LNL322/1S	72	LPL325	115
LF0024S	132	LFL122S	119	LNL323/2	73	LPL421	116
LF0025	131	LFL123	120	LNL324/3	73	LPL423	116
LF0122	131	LFL124	120	LNL324/3E	74	LPL424	117
LF0122S	131	LFX021	128	LNL324/3S	74	LPL425	117
LF2022H	133	LFX025	129	LNL325/3	73	LPL522	54
LF2023H	133	LFX121	128	LNL334/3W	06	LPL522B	55
LF2024H	134	LFX125	129	LNL423	69	LPL522C	56
LF4024N	142	LFX221	128	LNL7121/SI	70	LPL522CB	56
LF4025N	142	LFX225	129	LNL7121/WH	70	LPL523	54
LF4026N	142	LGL112S	119	LNL7221/CH	70	LPL523C	57
LF4027N	143	LGL211	124	LNL7321/WH	71	LPL523CB	57
LF4028N	143	LGL221	124	LNL7421/WH	71	LPL523B	55
LF6023	140	LGL311	124	LNL7521/CH	71	LPL524	54
LF6024	140	LGL321	124	LNL7621/WH	69	LPL524B	55
LF6025	141	LGL411	123	LNL7621/WHE	69	LS022	126
LF6027	141	LGL413	123	LNL822	64	LS023	126
LF6033W	06	LGL421	123	LNL823	64	LS024	127
LF7021	135	LGL423	123	LPL111	110	LS025	127
LF7021S	138	LGL514	122	LPL113	110	LS125	127
LF7022	135	LGL514S	122	LPL114	111	LS225	127
LF7022S	138	LGL524	122	LPL115	111	LSF101	121
LF7023	136	LGL524S	122	LPL121	110	LSL321N	20

LSL322	18	PL5523U	103	T4430UV	188	TP1510/GR	192
LSL322H	19	PL5524	103	T4431UV	188	TP1510/RD	192
LSL322N	20	PL5524U	103	T7201UV	189	TP1510/WH	192
LSL322HS	19	PL5525U	104	T7251UV	189	TP1510/YE	192
LSL323N	20	PL5722	104	TH01	190	TP1510/YG	192
LSL512	21	PL6221	105	TL102	76	TP1910/BK	193
LSL513	21	PL6221U	105	TL103	76	TP1910/BL	193
LSL521	21	PL7224	105	TL203	78	TP1910/BR	193
LSL522	21	PL7224U	105	TL301	77	TP1910/GR	193
LSL523	21	PSF103	121	TL301B	77	TP1910/RD	193
LSL621/RP	23	PSF104	121	TL302	77	TP1910/WH	193
LSL711	22	RLNL126	68	TL302B	77	TP1910/Y	193
LSL721	22	RLNL324	74	TL303	78	TP1910/YG	193
LSL722	22	RLU112	24	TL401	76	TP1920/BK	194
LSL723	22	RLU2/1	31	TLS201	182	TP1920/BL	194
LU112/SR	24	SM126	68	TLS202	182	TP1920/BR	194
LU221/1	26	SM2/1	31	TLS203	182	TP1920/GR	194
LU222/1	26	SN100	109	TLS221	182	TP1920/RD	194
LU222/DALI	27	SNN250	75	TLS222	182	TP1920/YE	194
LU223/1	27	SNR001	109	TLS223	182	TP1920/YG	194
LU321	25	SNR180	75	TLS301	183	TP2510/BK	195
LU321/1	29	SNR180/1	75	TLS302	183	TP3810/BK	195
LU322	25	T12031UV	189	TLS303	183	TP5010/BK	195
LU322/1	29	T2100UV	186	TLS321	183	TR7201UV	189
LU323	25	T2101UV	186	TLS322	183	TR7301UV	189
LU323/1	29	T2140UV	186	TLS323	183	WL01R	93
LU421	24	T2141UV	186	TLS4229	184	WL03R	93
ML01R	101	T2200UV	186	TLS5229	184	WL09R	94
MS121N	109	T3140UV	186	TLS6229	184	WL10R	94
MS521	106	T3141UV	186	TMA1212	191	WL11R	95
MS621	106	T3200UV	187	TMA1212/BK	191	WL20R	95
MS721	106	T3250UV	187	TMA1919	191	WL21R	96
PL121	107	T3251UV	187	TMA1919/BK	191	WL22R	96
PL121H	107	T3300UV	187	TMA2828	191	WL24R	96
PL121H/U	108	T4200UV	187	TMA2828/BK	191	WL25R	97
PL120P/U	108	T4201UV	187	TMS01	190	WL26R	97
PL5024	102	T4250UV	188	TMS01/BK	190	WLF101	121
PL5024U	102	T4251UV	188	TMS02	190	WLF102	121
PL5224	102	T4300UV	188	TMS02/BK	190	WLF103	121
PL5224U	102	T4301UV	188	TP1510/BK	192	WLF201	64
PL5224U	102	T4370UV	188	TP1510/BL	192	WLF211	64
PL5523	103	T4371UV	188	TP1510/BR	192	ZAF101	153

ZAF102	153	ZLS117	175	ZLS615C	178		
ZBF101	154	ZLS118	175	ZLS615CW	178	ZSF110	158
ZBF102	154	ZLS122	174	ZLS616C	179	ZSF111	158
ZFS101	152	ZLS126	174	ZLS616CD	179	ZSF112	159
ZFS102	152	ZLS127	175	ZLS624C	177	ZSF113	160
ZFS103	152	ZLS128	175	ZLS624CD	177	ZSF114	160
ZLF511	145	ZLS203	173	ZLS624COB	177	ZSF115	161
ZLF511A	144	ZLS213	173	ZLS625C	178	ZSF116	161
ZLF512	145	ZLS223	173	ZLS625CW	178	ZSF117	162
ZLF512A	144	ZLS313	181	ZLS626C	179	ZSF118	162
ZLF513	146	ZLS323	181	ZLS626CD	179	ZSF119	163
ZLF521	145	ZLS410	180	ZLS702	170	ZSF120	163
ZLF521A	144	ZLS420	180	ZLS704	170	ZSF121	164
ZLF522	145	ZLS421	180	ZLS712	170	ZSF122	164
ZLF522A	144	ZLS422	180	ZLS714	170	ZSF123	165
ZLF523	146	ZLS422CD	181	ZLS722	170	ZSF124	165
ZLF712	149	ZLS423	180	ZLS724	170	ZWF101	150
ZLF722	149	ZLS503	167	ZLS802	171	ZWF102	150
ZLF812	149	ZLS505	167	ZLS804	171	ZWF103	150
ZLF817	148	ZLS507	168	ZLS807	172	ZWF104	151
ZLF818	148	ZLS509	168	ZLS809	172	ZWF105	151
ZLF822	149	ZLS513	167	ZLS812	171	ZWF106	151
ZLF827	148	ZLS515	167	ZLS814	171	ZWF201	150
ZLF828	148	ZLS517	168	ZLS817	172	ZWF202	150
ZLF911	147	ZLS519	168	ZLS819	172	ZWF203	150
ZLF914	147	ZLS523	167	ZLS822	171	ZWF204	151
ZLF915	146	ZLS525	167	ZLS824	171	ZWF205	151
ZLF921	147	ZLS527	168	ZLS827	172	ZWF206	151
ZLF924	147	ZLS529	168	ZLS829	172		
ZLF925	146	ZLS561	166	ZLS912	169		
ZLS001	173	ZLS562	166	ZLS914	169		
ZLS012	176	ZLS571	166	ZLS922	169		
ZLS013	176	ZLS572	166	ZLS924	169		
ZLS021	173	ZLS581	166	ZSF101	155		
ZLS022	176	ZLS582	166	ZSF102	155		
ZLS023	176	ZLS604C	177	ZSF103	155		
ZLS102	174	ZLS604CD	177	ZSF104	156		
ZLS106	174	ZLS606C	179	ZSF105	156		
ZLS107	175	ZLS606CD	179	ZSF106	156		
ZLS108	175	ZLS614C	177	ZSF107	156		
ZLS112	174	ZLS614CD	177	ZSF108	157		
ZLS116	174	ZLS614COB	177	ZSF109	157		

Certificate of Compliance

Certificate Number: EN201402260002-1

Applicant : NEDES, s.p.a.
Hlavná 35 91021 Zelená, Slovakia

Manufacturer : NEDES, s.p.a.
Hlavná 35 91021 Zelená, Slovakia

Product : LED Bulb Light

Trade Name : NEDES

Model Number : F23A05, F23M05, F23B0A, F23C3, F23A6, F23A8, F23P04, F23P16, F23A80, F23A8, F23A75, F23A10, F23A15, F23C7, F23A4, F23A6, F23A8, F23A80

Test Standard : EN 60969:2012

The EUT described above has been tested by us with the listed standards and found in compliance with the council LVD Directive 2006/95/EC. It is possible to use CE marking to demonstrate the compliance with LVD Directive.

The certificate applies to the tested sample above mentioned only and shall not imply an assessment of the whole production. It is only valid in connection with the test report number: LN201402260002-1.

2014-08-26
Date of issue

United testing technology (Hong Kong) Limited
Unit 24, 17/F, Bright Way Tower No. 33 Mong Kok Road, Kowloon, HK.
4/F, Unit 2, Janning Building, Cheung Kong Industry Area, West Kowloon Road, Namwan District, Shenzhen, PRC.
Tel: +86-755-89183096 Fax: +86-755-89183136
<http://www.lntest.com> E-mail: info@lntest.com

Certificate of Compliance

Certificate Number: EN201402260002-1

Applicant : NEDES, s.p.a.
Hlavná 35 91021 Zelená, Slovakia

Manufacturer : NEDES, s.p.a.
Hlavná 35 91021 Zelená, Slovakia

Product : LED Bulb Light

Trade Name : NEDES

Model Number : F23A05, F23M05, F23B0A, F23C3, F23A6, F23A8, F23P04, F23P16, F23A80, F23A8, F23A75, F23A10, F23A15, F23C7, F23A4, F23A6, F23A8, F23A80

Test Standard : IEC62321:2013

The EUT described above has been consolidated by us and found in compliance with the council RoHS Directive 2002/95/EC. It is only valid in connection with the test report number: LN201402260002-1.

2014-08-26
Date of issue

 **RoHS** 

United testing technology (Hong Kong) Limited
Unit 24, 17/F, Bright Way Tower No. 33 Mong Kok Road, Kowloon, HK.
4/F, Unit 2, Janning Building, Cheung Kong Industry Area, West Kowloon Road, Namwan District, Shenzhen, PRC.
Tel: +86-755-89183096 Fax: +86-755-89183136
<http://www.lntest.com> E-mail: info@lntest.com

Certificate of Compliance

Certificate Number: EN201402260002-1

Applicant : NEDES, s.p.a.
Hlavná 35 91021 Zelená, Slovakia

Manufacturer : NEDES, s.p.a.
Hlavná 35 91021 Zelená, Slovakia

Product : LED Bulb Light

Trade Name : NEDES

Model : F23A05, F23M05, F23B0A, F23C3, F23A6, F23A8, F23P04, F23P16, F23A80, F23A8, F23A75, F23A10, F23A15, F23C7, F23A4, F23A6, F23A8, F23A80

Test Standard : EN60529:2012
EN60529:2008
EN61000-3-2:2006+A1:2009+A2:2009, EN61000-3-3:2013
EN61000-4-2:2009, EN61000-4-3:2009+A2:2010,
EN61000-4-4:2009+A1:2010, EN61000-4-5:2009, EN61000-4-6:2009,
EN61000-4-8:2010, EN61000-4-11:2004

The EUT described above has been tested by us with the listed standards and found in compliance with the council EMC Directive 2004/108/EC. It is possible to use CE marking to demonstrate the compliance with EMC Directive.

The certificate applies to the tested sample above mentioned only and shall not imply an assessment of the whole production. It is only valid in connection with the test report number: LN201402260002-1.

2014-08-26
Date of issue

United testing technology (Hong Kong) Limited
Unit 24, 17/F, Bright Way Tower No. 33 Mong Kok Road, Kowloon, HK.
4/F, Unit 2, Janning Building, Cheung Kong Industry Area, West Kowloon Road, Namwan District, Shenzhen, PRC.
Tel: +86-755-89183096 Fax: +86-755-89183136
<http://www.lntest.com> E-mail: info@lntest.com

Certificate of Compliance

Certificate Number: EN201402260002-1

Applicant : NEDES, s.p.a.
Hlavná 35 91021 Zelená, Slovakia

Manufacturer : NEDES, s.p.a.
Hlavná 35 91021 Zelená, Slovakia

Product : LED Light

Trade Name : NEDES

Model : GR, GA, GG016, GRN16, LG016, LMR16, GU10-120, MR16-120, GR33, WL328, WL488, GU10-8730-SMD, GU10-COB, GU10-3528-SMD

Test Standard : EN 62380:2012

The EUT described above has been tested by us with the listed standards and found in compliance with the council LVD Directive 2006/95/EC. It is possible to use CE marking to demonstrate the compliance with LVD Directive.

The certificate applies to the tested sample above mentioned only and shall not imply an assessment of the whole production. It is only valid in connection with the test report number: LN201402260002-1.

2014-08-26
Date of issue

United testing technology (Hong Kong) Limited
Unit 24, 17/F, Bright Way Tower No. 33 Mong Kok Road, Kowloon, HK.
4/F, Unit 2, Janning Building, Cheung Kong Industry Area, West Kowloon Road, Namwan District, Shenzhen, PRC.
Tel: +86-755-89183096 Fax: +86-755-89183136
<http://www.lntest.com> E-mail: info@lntest.com

Certificate of Compliance

Certificate Number: EN201402260002-1

Applicant : NEDES, s.p.a.
Hlavná 35 91021 Zelená, Slovakia

Manufacturer : NEDES, s.p.a.
Hlavná 35 91021 Zelená, Slovakia

Product : LED Light

Trade Name : NEDES

Model : GR, GA, GG016, GRN16, LG016, LMR16, GU10-120, MR16-120, GR33, WL328, WL488, GU10-8730-SMD, GU10-COB, GU10-3528-SMD

Test Standard : IEC62321:2013

The EUT described above has been consolidated by us and found in compliance with the council RoHS Directive 2002/95/EC. It is only valid in connection with the test report number: LN201402260002-1.

2014-08-26
Date of issue

 **RoHS** 

United testing technology (Hong Kong) Limited
Unit 24, 17/F, Bright Way Tower No. 33 Mong Kok Road, Kowloon, HK.
4/F, Unit 2, Janning Building, Cheung Kong Industry Area, West Kowloon Road, Namwan District, Shenzhen, PRC.
Tel: +86-755-89183096 Fax: +86-755-89183136
<http://www.lntest.com> E-mail: info@lntest.com

Certificate of Compliance

Certificate Number: EN201402260002-1

Applicant : NEDES, s.p.a.
Hlavná 35 91021 Zelená, Slovakia

Manufacturer : NEDES, s.p.a.
Hlavná 35 91021 Zelená, Slovakia

Product : LED Light

Trade Name : NEDES

Model : GR, GA, GG016, GRN16, LG016, LMR16, GU10-120, MR16-120, GR33, WL328, WL488, GU10-8730-SMD, GU10-COB, GU10-3528-SMD

Test Standard : EN60529:2012
EN60529:2008
EN61000-3-2:2006+A1:2009+A2:2009, EN61000-3-3:2013
EN61000-4-2:2009, EN61000-4-3:2009+A2:2010,
EN61000-4-4:2009+A1:2010, EN61000-4-5:2009, EN61000-4-6:2009,
EN61000-4-8:2010, EN61000-4-11:2004

The EUT described above has been tested by us with the listed standards and found in compliance with the council EMC Directive 2004/108/EC. It is possible to use CE marking to demonstrate the compliance with EMC Directive.

The certificate applies to the tested sample above mentioned only and shall not imply an assessment of the whole production. It is only valid in connection with the test report number: LN201402260002-1.

2014-08-26
Date of issue

United testing technology (Hong Kong) Limited
Unit 24, 17/F, Bright Way Tower No. 33 Mong Kok Road, Kowloon, HK.
4/F, Unit 2, Janning Building, Cheung Kong Industry Area, West Kowloon Road, Namwan District, Shenzhen, PRC.
Tel: +86-755-89183096 Fax: +86-755-89183136
<http://www.lntest.com> E-mail: info@lntest.com



NEDES s.r.o.
Hlavná 35, 91921 Zeleneč, Slovensko
nedes@nedes.eu
IČO: 46257691
IČDPH: SK2023295054

www.nedes.eu